

# BOMATEC

BOMATEC expressly reserves the right to change its products and/or specifications. An info letter gives details as to any amendments and additions made to the relevant current specifications on our internet website [www.sino-lid.cn](http://www.sino-lid.cn); this letter is generated automatically and shall be sent to registered users by email. Copying – even as an excerpt – is only permitted with bomatec' approval in writing and precise reference to source. bomatec does not warrant the accuracy, completeness or timeliness of the specification and does not assume liability for any errors or omissions in these materials. The data specified is intended solely for the purpose of product description. No representations or warranties, either express or implied, of merchantability, fitness for a particular purpose or of any other nature are made hereunder with respect to information/specification or the products to which information refers and no guarantee with respect to compliance to the intended use is given. In particular, this also applies to the stated possible applications or areas of applications of the product.

BOMATEC conveys no patent, copyright, mask work right or other trade mark right to this product. BOMATEC assumes no liability for any patent and/or other trade mark rights of a third party resulting from processing or handling of the product and/or any other use of the product.

As a general rule our developments, IPs, principle circuitry and range of Integrated Circuits are suitable and specifically designed for appropriate use in technical applications, such as in devices, systems and any kind of technical equipment, in so far as they do not infringe existing patent rights. In principle the range of use is limitless in a technical sense and refers to the products listed in the inventory of goods compiled for the 2008 and following export trade statistics issued annually by the Bureau of Statistics in Wiesbaden, for example, or to any product in the product catalogue published for the 2007 and following exhibitions in Hanover (Hannover-Messe).

We understand suitable application of our published designs to be state-of-the-art technology which can no longer be classed as inventive under the stipulations of patent law. Our explicit application notes are to be treated only as mere examples of the many possible and extremely advantageous uses our products can be put to.



[www.machineryhouse.com.au](http://www.machineryhouse.com.au)

[www.machineryhouse.co.nz](http://www.machineryhouse.co.nz)

# SINO | BOMATEC

## DIGITAL READOUTS

### Operation Manual

[www.machineryhouse.com.au](http://www.machineryhouse.com.au)

## Contents

|   |    |
|---|----|
| <b>Chapter 1. INTRODUCTION</b>                        | 3  |
| 1.1 Front Panel                                       | 3  |
| 1.2 Back Panel  | 4  |
| 1.3 Description of Key Function                       | 5  |
| 1.4 Interface   | 7  |
| 1.5 Coordinate System                                 | 8  |
| <b>Chapter 2. BASIC OPERATION</b>                     | 9  |
| 2.1 Power on  | 9  |
| 2.2 Zeroing   | 9  |
| 2.3 Preset Data to Designated Axis                    | 10 |
| 2.4 Toggle display unit between mm and inch           | 11 |
| 2.5 Mid-point Calculation                             | 11 |
| 2.6 Set the Shrinkage Mode                            | 12 |
| 2.7 Absolute / Incremental / 1000 groups SDM          | 13 |
| 2.8 Clear All SDM Datum                               | 14 |
| 2.9 Search the Absolute Reference Point of Scale (RI) | 15 |
| 2.10 Clear the Error message                          | 16 |
| 2.11 Lathe Function                                   | 16 |
| 2.12 Filter display value                             | 17 |
| <b>Chapter 3 1000 GROUPS SDM COORDINATE</b>           | 18 |
| 3.1 Zeroing at the Current Point                      | 18 |
| 3.2 Preset datum of SDM Coordinate                    | 20 |
| <b>Chapter 4 SPECIAL FUNCTION</b>                     | 22 |
| 4.1 Bolt Hole Circle                                  | 22 |
| 4.2 Bolt Hole Line                                    | 24 |
| 4.3 ARC Processing                                    | 26 |
| 4.4 Slope Processing                                  | 30 |
| 4.5 Auto Edge Detection                               | 33 |
| <b>Chapter 5. EDM</b>                                 | 35 |
| 5.1 Setting EDM Parameters                            | 36 |
| 5.2 EDM machining                                     | 37 |
| 5.2.1 Example for Mode 1 with Plus Depth              | 37 |
| 5.2.2 Example for Mode 1 with Minus Depth             | 38 |

|  |    |
|--|----|
| 5.2.3 Example for Mode 2   | 40 |
| 5.2.4 Example for Mode 3   | 41 |
| 5.2.5 Example for Mode 4 with Minus Depth                          | 42 |
| 5.2.6 Example for Mode 6   | 44 |
| 5.2.7 Example for Mode 7   | 45 |
| 5.3 Combination of BHC: BHL and EDM Function                       | 47 |
| <b>Chapter 6 CALCULATOR FUNCTION</b>                               | 49 |
| 6.1 Enter and exit Calculator Function                             | 49 |
| 6.2 Calculating Example  | 49 |
| 6.3 Transferring the Calculated Results to Selected Axis           | 49 |
| 6.4 Transferring the Current Display Value in Window to Calculator | 50 |
| <b>Chapter 7 INITIAL SYSTEM SETTINGS</b>                           | 51 |
| 7.1 Enter/Exit Initial System Settings                             | 51 |
| 7.2 Setting the type of DRO  | 52 |
| 7.3 Setting Positive Direction for Counter                         | 52 |
| 7.4 Setting Linear Compensation                                    | 53 |
| 7.5 Toggle Between R/D Display Mode                                | 55 |
| 7.6 Setting Z axis Dial  | 56 |
| 7.7 Setting the Resolution of Scale                                | 57 |
| 7.8 Setting Relay Mode   | 58 |
| 7.9 Setting the EDM Mode   | 59 |
| 7.11 Enable / Disable ERROR Signal                                 | 60 |
| 7.12 Setting Shrinkage Ratio                                       | 61 |
| 7.13 Enable/Disable EDM Depth Compensation                         | 61 |
| 7.14 Setting the Slope Machining Parameter                         | 62 |
| 7.15 Setting Lathe Mode  | 63 |
| 7.16 Setting RI MODE   | 63 |
| 7.17 Enable/Disable Edge Detection                                 | 64 |
| 7.18 Toggle between Linear Scale and Rotary Encoder                | 65 |
| 7.19 Step Mode of ARC  | 65 |
| 7.20 Angle Display Mode  | 66 |
| 7.21 Angle display type  | 67 |
| 7.22 Load default setup  | 68 |
| <b>Chapter 8 TROUBLES HOOTING</b>                                  | 70 |

Chapter 1. INTRODUCTION

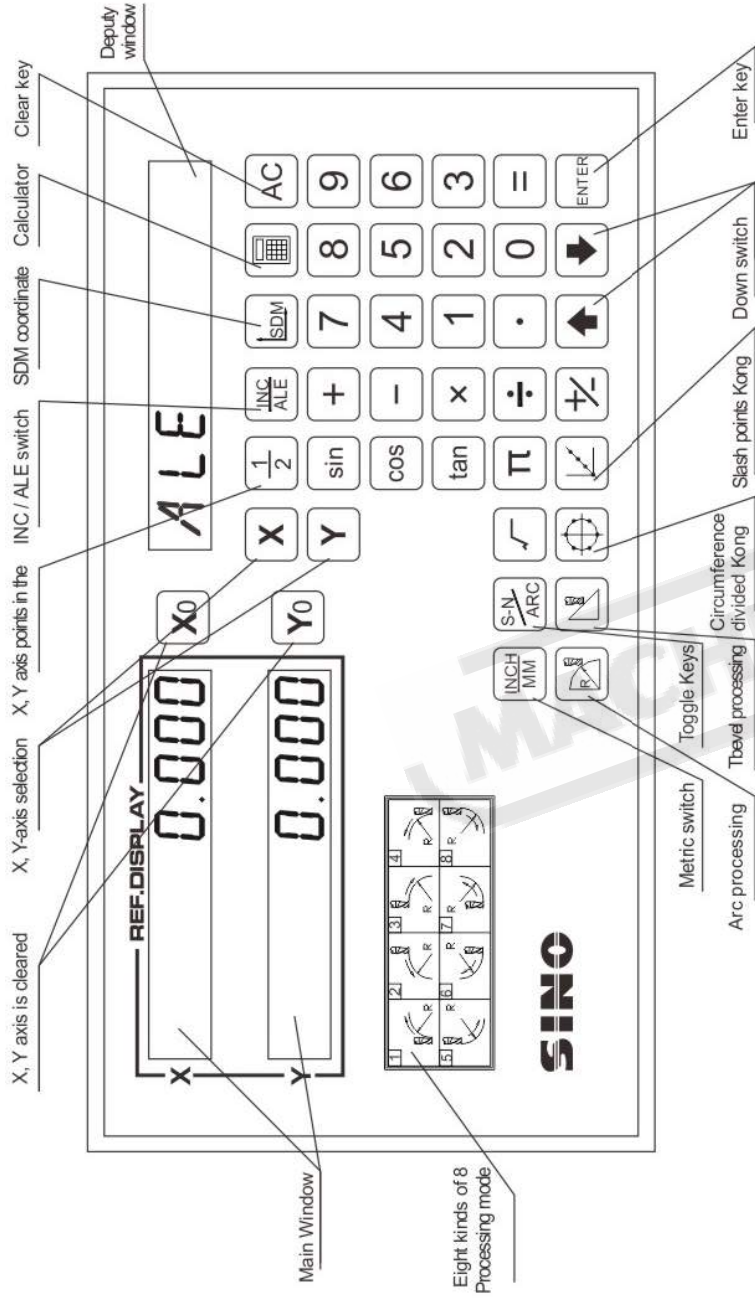

Eight kinds of 8 Processing mode

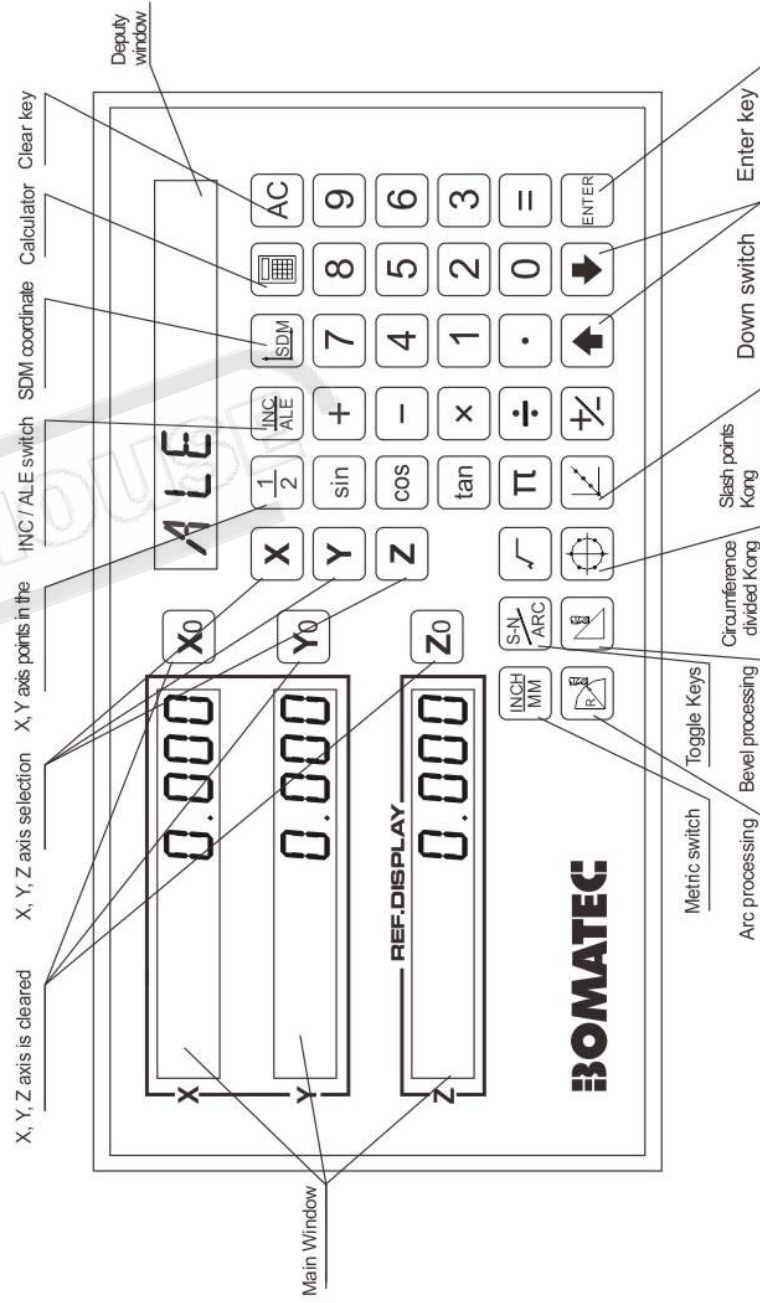



### 1.3 Description of Key Function

#### XH USER'S MANUAL

|    | KEY MARK | KEY NAME           | FUNCTION   | WE6800-2 | WE6800-3 | WE6800-E |
|----|----------|--------------------|--|----------|----------|----------|
| 1  |          | X/Y/Z-Zero         | Zero selected axis.  | No       |          |          |
| 2  |          | Axis Selection     | Select axis to operate.  | No       |          |          |
| 3  |          | Inch/Metric Switch | Toggle display unit between metric and inch.   |          |          |          |
| 4  |          | Center Finding     | Half a display value of an axis.   |          |          |          |
| 5  |          | ALE/IINC Switch    | Toggle between ALE/INC coordinate.   |          |          |          |
| 6  |          | RI Finding         | Find the origin of the linear scale.   |          |          |          |
| 7  |          | Shrinkage          | Toggle between shrinkage and unshrinkage.  |          |          |          |
| 8  |          | SDM Switch         | Second data memory.  |          |          |          |
| 9  |          | Numeric Key        | Enter number.  |          |          |          |
| 10 |          | Decimal Point      | Enter decimal point.   |          |          |          |
| 11 |          | +/- Sign           | Enter +/- sign.  |          |          |          |
| 12 |          | Enter              | Confirm operation.   |          |          |          |
| 13 |          | Clearing           | Cancel incorrect operation.  |          |          |          |
| 14 |          | Temporary Quit     | 1. Leave processing temporarily to return normal display state.<br>2. Enter auto edge detect function. |          | X        | X        |
| 15 |          | Temporary Quit     | 1. Leave processing temporarily to return normal display state.<br>2. Enter auto edge detection.       | X        |          |          |

#### XH USER'S MANUAL

|    |  |                                 |  |   |   |   |
|----|--|---------------------------------|--|---|---|---|
| 16 |  | Calculator                      | Enter /quit calculating state.   |   |   |   |
| 17 |  | Shift                           | 1 Calculate inverse trigonometric unction in calculating function.<br>2 Enter No. of SDM coordinate. |   |   |   |
| 18 |  | Trigonometric Function          | Calculate trigonometric or inverse trigonometric.  |   |   |   |
| 19 |  | Add: Decrease: Multiple: Divide | Operate adding: decreasing: multiplying: dividing.   |   |   |   |
| 20 |  | Radical Sign                    | Square root or square.   |   |   |   |
| 21 |  | Circumference Ratio             | Enter circumference ratio.   |   |   |   |
| 22 |  | Equality Sign                   | Make calculating result.   |   |   |   |
| 23 |  | Set EDM                         | Set parameters of EDM.   | X | X |   |
| 24 |  | BHC                             | Process holes displayed equally on a circle.   |   |   |   |
| 25 |  | Start EDM                       | Enter EDM processing.  | X | X |   |
| 26 |  | ARC                             | Simple R cutting function  |   |   | X |
| 27 |  | BHL                             | Process holes displayed equally on a line.   |   |   |   |
| 28 |  | SLOPE                           | Process a slope.   |   |   | X |
| 29 |  | Lathe Function                  | Enter or exit lathe function.  |   | X | X |
| 30 |  | Lathe Function                  | Enter or exit lathe function.  | X |   | X |
| 31 |  | Item Selection                  | Stroll up or down to select.   |   |   |   |

Note: -X|| indicates this model has no such a function.

1.4 Interface

A Linear Scale Interface

1) 9PD Connector

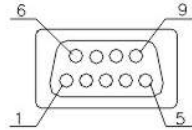

| PIN | NAME | COLOR |
|-----|------|-------|
| 1   | +5V  | RED   |
| 2   | 0V   | BLK   |
| 3   | A    | BRW   |
| 4   | B    | YEL   |
| 5   | RI   | ORG   |

2) 15PD Connector

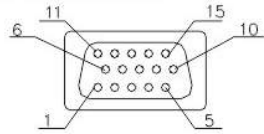

| PIN | NAME | COLOR |
|-----|------|-------|
| 1   | +5V  | RED   |
| 2   | 0V   | BLK   |
| 3   | A    | BRW   |
| 4   | B    | YEL   |
| 5   | RI   | ORG   |

3) 7Pin Connector

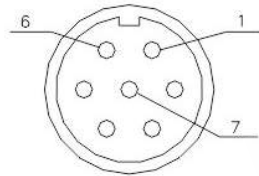

| PIN | NAME | COLOR      |
|-----|------|------------|
| 1   | 0V   | BLK        |
| 2   | NC   |            |
| 3   | A    |            |
| 4   | B    | YEL        |
| 5   | +5V  | RED        |
| 6   | RI   | ORG        |
| 7   | FG   | SHILD WIRE |

B RS232 Interface

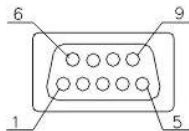

| PIN | NAME | COLOR |
|-----|------|-------|
| 1   | NC   |       |
| 2   | TXD  | YEL   |
| 3   | RXD  | ORG   |
| 4   | NC   |       |
| 5   | GND  | BRW   |

C EDM Interface

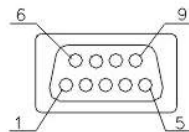

| PIN | NAME         | COLOR |
|-----|--------------|-------|
| 1   | NC           |       |
| 2   | COMMON       | ORG   |
| 3   | NORMAL CLDSE | BRW   |
| 4   | NC           |       |
| 5   | IN+          | RED   |
| 6   | NORMAL OPEN  | YEL   |
| 9   | IN-          | BLK   |

1.5 Coodfinate System

XH DRO is an instrument which can measure position of work piece when processing. Coordinate system must be definite first for more efficiency and accuracy.

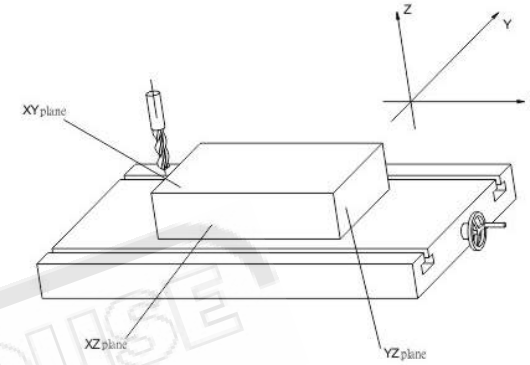

In horizontal plane, the X axis is parallel with the operator; Y axis is perpendicular to X axis. Z-axis is perpendicular to horizontal plane. Positive direction of axis is set as the figure. It also can be changed as customer.

The value of one point position is the distance relative to the origin of coord inate.

For a work-piece as Figure A, the value of each point position is as the Figure B when point O is the origin of coordinate.

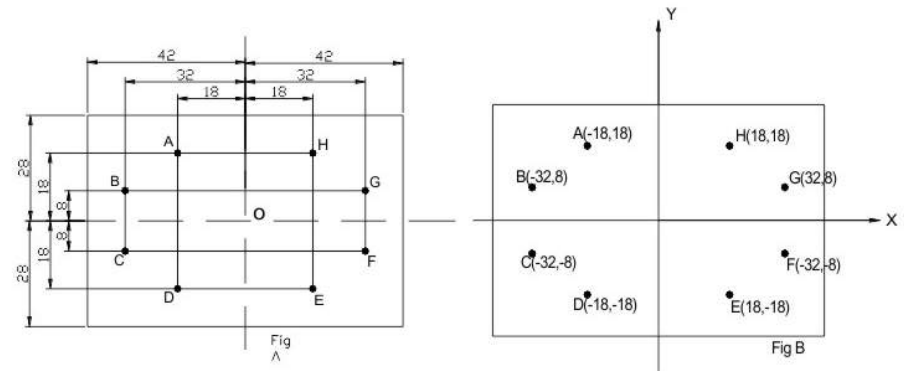

## Chapter 2. BASIC OPERATION

### 2.1 Power on

Function: Power on then XH enter normal display state.

It can memorize the following parameter after power on.

- A. The scale position where power off;
- B. ALE/INC/SDM mode;
- C. Shrinkage is enabled or disable;
- D. Metric/Imperial mode;

The origin of the linear scale must be searched again if the scale is moved when power off.

Note: Normal display state

The state DRO automatically enters after on or exit from "STEUP".

In normal display state, X window, Y window and Z window displays the current value of X axis, Y axis and Z axis separately. The message window displays "ALE", "INC" or "SDM XXX" (indicate the Number of SDM coordinate, with a range of 000—999). When user switch among ALE/INC/SDM, MM/INCH or shrinkage / Un-shrinkage, DRO will not leave this state. When you enter CALCULATOR function, input data to X (or Y or Z) axis, function of searching the Reference point (RI) of the linear scale or special function (BHC: BHL: ARC: SLOPE PROCESSING and EDM function): DRO is not in the normal display state.

### 2.1 Power on

Function: Zero the designated axis in normal display state. Zeroing is used to set the current point as datum point.

Note:

- 1 The axis can't be zeroed when DRO is in other states (for example: in the state of calculating function or in special function). DRO should return normal display state;
- 2 The axes can be zeroed in ALE/INC/SDM states;
- 3 When zero in ALE coordinate, INC display value is cleared simultaneously. Zeroing in INC coordinate has no effect on ALE and SDM display value.
- 4 Press the zero key of the same axis will cancel above zero operation if the scale kept still after zero.
- 5 zero is means that set the current point as the origin point of current axis.

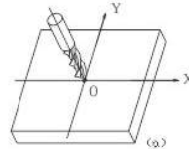

Example 1: Set the point O (as the figure illustrated) as datum

STEPS:

1) Return normal display state;

2) Move the machine table; and align the lathe tool with point O.  
The DRO displays as the right figure.

3) Press  $X_0$  to zero X axis,

Press  $Y_0$  to zero Y axis.



### 2.3 PresetData to designed axis

Function: Preset a value to current position for a designed axis in normal display state.

- NOTES:
- 1 Axis can not be preset while the DRO is in other states (e.g. calculating function or special function). DRO should return normal display state before presetting data.
  - 2 Axis can be preset in ALE/INC/SDM state.
  - 3 In SDM state, input mode "0" means that the display value is equal to the enter value; input mode "1" means that the display value is equal to the negative of enter value.
  - 4 The range of input value is that the minimum value to the maximum value which could be displayed in the designated window.

Example: Machine the work-piece from the figure (a) to figure(b), and the plane C is the datum and counting direction is right.

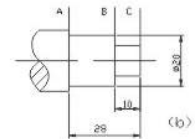
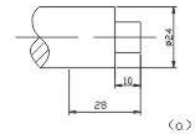

STEPS:

1. Move the machine table, and align the lathe tool to plane B.
2. Return normal display state;
3. Press  $X$ , "0" is flashing in X window, waiting for entering a data;
4. Press  $1$   $0$   $Z$  in turn, which means the preset data is "-10";  
If incorrect value is inputted: press  $AC$  to cancel and input again;

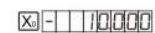
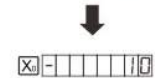
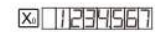

NOTE: If in SDM state and SDM input mode is "1",  $Z$  needn't be inputted. Otherwise  $Z$  must be inputted.

5. Press  $ENTER$  to confirm the data that your input and end presetting it to X axis;
6. Moving the machine table until "-28.000" is displayed in X window. Now it is the position of plane A.
7. Y axis, Z axis can be preset in the same way.



### 2.4 Toggle display unit between mm and inch

Function: Length can be displayed either in “mm” (metric) or “inch”(imperial) Display unit can be toggled between mm and inch.

Example: Display value toggle from mm to inch

STEPS:

1. DRO returns normal display state. The LED of INCH is off, which means the current unit is mm (metric);
2. Press  $\frac{INCH}{MM}$ , then the LED of INCH/mm is on, which means the display unit is inch now.
3. It is invalid to toggle between mm and inch while axis is encoder.

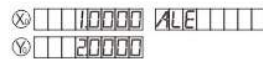
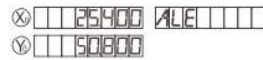

**NOTE: If in imperial, the LED of INCH is on; and in metric unit, the LED of INCH is off.**

### 2.5 Mid-point Calculation

Function: Set the center of work pieces datum by halving the displayed value.

Example: Set the center of rectangle as datum as the right figure.

STEPS:

1. Place the work piece on the machine table, with line AB parallel with X axis, line AD parallel to Y axis;
2. DRO returns normal display state, move machine table and align the lathe tool with point A;  
Press  $X_0$  to zero X axis, press to  $Y_0$  zero Y axis;
3. Align lathe tool with point C by moving machine table;  
Press  $\frac{1}{2}$ ,  $X$  in turn to halve the X axis display value;  
Press  $\frac{1}{2}$ ,  $Y$  in turn to halve the Y axis display value;

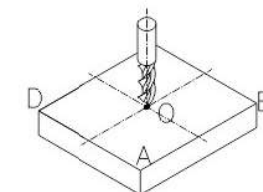
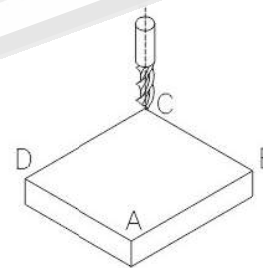
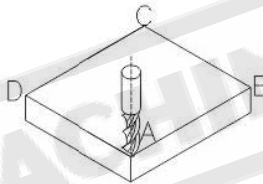
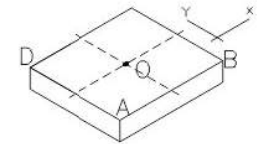
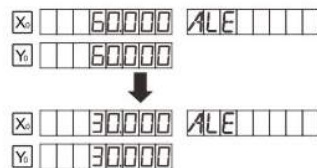
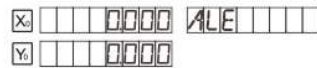

4. Move the machine table until —0.0001 is displayed in X window and X window. The position (where the lathe tool is) is the work-piece’s center.

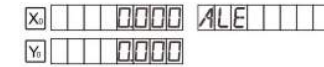

**Note: 1. If you do other operation after axis half, please press  $\frac{1}{2}$ ,  $X_0$  will cancel above operation, and X-axis display value return to normal.**

**2. It is invalid to mid-point calculation while axis is encoder.**

### 2.6 Set the Shrinkage mode

Function: With this function, you can process the mould tools according to the dimension of the finished products without calculating dimension separately.  
display value = actual value x shrink ratio.

STEPS:

A. unshrinkage → shrinking

1. DRO returns normal display state;
2. Press  $\frac{1}{2}$  and don't release. The Y window displays the current shrinkage ratio, the message window displays “SURE AGN”, which means you need to confirm once again.

3. Press  $\frac{1}{2}$  to enter shrinkage state; press any other key to return former state.

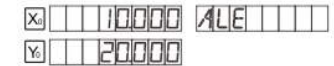

**NOTE: I  $\frac{1}{2}$  should not be released and press  $\frac{1}{2}$  simultaneously to enter shrinkage state; LED of shrinkage flashes in shrinkage mode;**

**II You can view the shrink ratio by making use of this function: press  $\frac{1}{2}$  will display shrink ratio of Y axis; Then press any key can return normal state;**

**III The signal light of shrink ratio will flicker while in shrinkage.**

B. shrinkage → unshrinking.

1. DRO returns normal display state;
2. Press  $\frac{1}{2}$ , now DRO is in unshrinking mode, LED of shrinkage is off;



## 2.7 Absolute / Incremental / 1000 groups SDM

Function: The XH series DRO has 3 display modes: the absolute mode (ALE); the incremental mode (INC) and 1000 groups Second Data Memory (SDM) with the range of 000 to 999.

1. Zero point of work-piece is set at the origin point of ALE coordinate;
2. The relative distance between datum of ALE and SDM remains unchanged when ALE datum is changed.
3. If one point in ALE is zeroed, the point in INC is zeroed automatically; yet if one point in INC is zeroed, the point in ALE will remain unchanged.

### I. toggle among ALE/INC/SDM coordinate

These three display modes can be changed only in normal display state.

ALE → INC Press

INC → ALE Press

SDM → INC Press to enter ALE or INC. If in ALE: press again.

SDM → ALE Press to enter ALE or INC. If in INC: press again.

INC → SDM Press

ALE → SDM Press

### II. Set the new number of SDM in SDM mode

STEPS:

1. Enter SDM mode;
2. Press (two axes DRO) or (three axes DRO), message window flashes, waiting for inputting a new number of SDM;
3. Enter a new number. for example, enter .
4. Confirm new SDM number.

SDM 234

SDM 666

Press (two axes DRO) or (three axes DRO), then the message window stops flashing and the number of SDM is changed to 666.

### III: Increase/Decrease the SDM number

DRO return normal display state with the display mode SDM, press to decrease the number of SDM by 1; press to increase the number of SDM by 1. Example: If the current SDM number is 777, and the message window displays "SDM 777", press , then the message window will display "SDM 776", which means the current SDM number is 776.

If the current SDM number is 777 and the message window displays "SDM 777",

press , then the message window will displays "SDM 778", which means the current SDM number is 778.

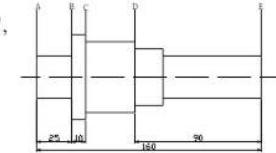

If a work-piece as the figure is to be machined where the datum plane is plane E, the coordinate can be set as the following steps:

1. Return normal display state with ALE coordinate;
2. Move the machine table until the lathe tool is aligned with plane E, then zero X axis;
3. Move the machine table until the lathe tool is aligned with the plane D. Change SDM number to SDM 000, and press to zero X axis. Then the NO.000 SDM coordinate's datum is set at plane D.
4. Move the machine table until the lathe tool is aligned with plane C, press to change SDM to SDM 001, and then press to zero X axis, and the SDM 001 with the datum plane C is set.
5. Move the machine table until the lathe tool touches the plane B, the DRO will display as the right.
6. Move the machine table until the lathe tool touches the plane A, the DRO will display as the right.

0000 ALE

-0000 ALE

0000 SDM 000

-0000 SDM 000

0000 SDM 001

-0000 SDM 001

-0000 SDM 001

## 2.8 Clear All SDM Datum

Function: Clear the Datum of all SDM 0-999. After clearing, the display value in SDM coordinate is equal to the value in ALE coordinate.

STEPS:

1. Return normal display state;
2. Press and simultaneously for 2 seconds, and the message window displays "CLS SDM" and flashes, which means it is clearing now. About ten seconds later, the clearing is completed and "CLS OK" is displayed in message window temporary and DRO return normal display state.



### 2.9 Search the Absolute Reference Point of Scale (RI)

Function: An absolute datum should be set when a work-piece is machined. There are two cases:

➤ When the machine table is going in high speed, the machine table can't stop immediately but continue going further because of inertia when power is off suddenly. There will be distance  $\Delta L$  between the actual position and the position in the DRO memorize. That is to say the display value is not the actual value of the position when power is on again.

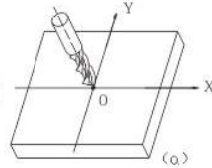

➤ If the machine table is moved without intention when DRO is off.

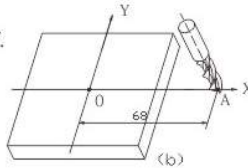

How to restore the preset ALE and correct display value? These questions can be solved easily with this function of search RI.

STEPS:

1. DRO is set in ALE coordinate.
2. Press  $\square_{RI}$ , then the message window displays "SEL AXIS";
3. Select the axis which need search RI. For instance: select Y axis, then press  $\square_Y$ . "FD.Y REF" is displayed in message window, and Y window flashes.
4. Move the machine table. The buzzer sounds when RI is searched, then Y window stops flashing and displays the value of the current position, the DRO returns normal display state.

In the course of searching, press  $\square_{AC}$  to quit this operation.



The machine table is moved when DRO is off. How to restore the former absolute ALE coordinate and correct display value?

Take XH-2 as an example.

STEPS:

- 1) This operation (searching the absolute origin point of the scale) is necessary when a linear scale is installed or the default parameter is loaded. Or the ALE coordinate would not be restored.
- 2) Set the point O as the datum of ALE. (Move the machine

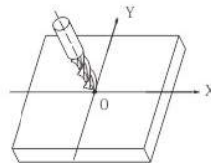

3) table until the lathe tool is aligned with point O, and zero the X axis, Y axis)

3) The machine table is moved when power is off;

4) Power on, switch to ALE coordinate. The DRO may be displays as the right.

5) Search the RI of X axis and Y axis. After RI is found, the ALE coordinate is restored.

6) Align the lathe tool with point O, "0.000" is displayed in X window and Y window, which means the point O is the origin and the ALE coordinate is restored.

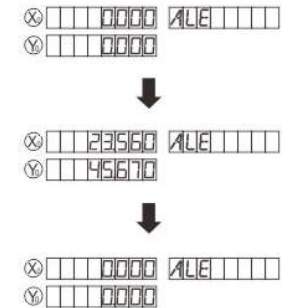

NOTE:

- The linear scale has a RI every 50 mm. For the sake of search identical RI, move the scale around the red mark "Δ" to search RI.
- Setup correct RI mode is a premise.

### 2.10 Clear the Error message

If ERROR message is enabled, the message window will display "E1" if the signal of phase A and phase B of the linear scale changes at the same time; the message window will display "E2" if the linear scale runs too fast; the window will display "E3" if these two conditions occur simultaneously. When error information appears, the display value has an error of 1-2 count. So users need search RI to restore ALE coordinate. If you think that doesn't affect your work, press  $\square_{AC}$  to clear error message and continue your work.

Example: When signal of A phase and B phase is same in Y axis the window displays as the right figure.

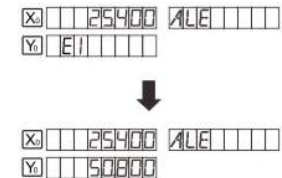

Press  $\square_{AC}$  to clear the error information. Y window displays the value, but it is error. The difference between the display value and the true value is about 1-2 times of resolution. For instance, the resolution of scale is 5μm; the difference is 5-10μm.

### 2.11 Lathe Function

As the right figure, if two scales are installed in one axis, the position of the work-piece should be the sum of these two values (X+Y) in this

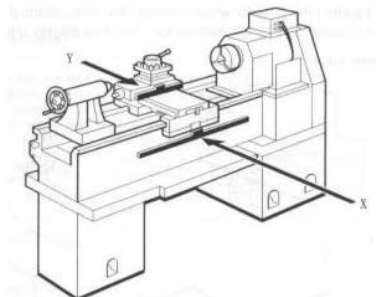

direction. It is called lathe function.

- A. lathe mode 0: normal display (the lathe function is disabled).
- B. lathe mode 1: X window value = the value of X axis position + the value of Y axis position.
- C. lathe mode 2: X window value = the value of X axis position + the value of Z axis position.

STEPS:

1. Set the lathe mode in initial system settings;
2. In normal display state press  $\boxed{X\frac{Y}{Z}}$  (three axes display) or  $\boxed{X+Y}$  (two axes display) to enter lathe function. Then the LED of the lathe function will be on (If the lathe mode is 0, the lathe function is disabled and the LED is off);
3. In lathe state, press  $\boxed{X\frac{Y}{Z}}$  (three axes display) or  $\boxed{X+Y}$  (two axes display) to exit the lathe function: and the LED turns off.

A. If in normal display state: the value of the position is as theright.

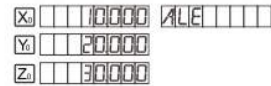

B. In lathe mode 1, the DRO will display as the following: X window display value = value of X axis position + value of Y axis position



C. In lathe mode 2, the DRO will display as the following: X window display value = value of X axis position + value of Z axis position

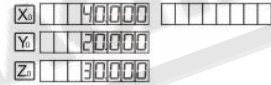

2.12 Filterdisplay value

When machine a work-piece by grinder, the display value varies quickly due to the vibration of grinder. User can't see display value clearly. XH series DRO provides display value filter function to disable the quake change of display value.

STEP:

- 1) Enter display value filter function.  
In normal display state, press  $\boxed{F5}$  and  $\boxed{ENTER}$  simultaneously, enter display value filter function.

- 2) Exit display value filter function.  
Press  $\boxed{F5}$ , exit display value filter function.

Chapter 3. 1000groups SDM coordinate

XH has three display modes: the absolute mode(ALE),the incremental mode(INC)and the 1000 groupssecond data memory (SDM 0—SDM999).

ALE datum of the work-piece is set at the beginning of the processing and the 1000 group SDM is set relative to ALE coordinate.

1000 group SDM coordinate can be divided into several segments, and every segment stores data of one work-piece. If one segment has 20 groups SDM coordinate, DRO can be divided into 50 segments and can store data of 50 work-pieces.

- SDM 000 -----SDM 019 data of the first work-piece
- SDM 020 -----SDM 039 data of the second work-piece
- SDM 040 -----SDM 059 data of the third work-piece
- .....
- SDM 960 -----SDM 979 data of 49th work-piece
- SDM 980 -----SDM 999 data of 50th work-piece

Example: The ALE datum is the center point O, the point E, F, G, H needed processing are set as datum of SDM 000 —SDM 003.

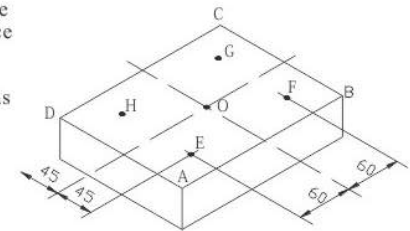

- Two ways to set SDM coordinates:
- 1) Zeroing at the current point.
  - 2) Presetting datum of SDM coordinate.

3.1 Zeroing at the Current Point

At first set the center point of the work-piece as the origin of the ALE, then align the lathe tool with point E, F, G, H by moving the machine table and zero them. It is the position to process where the "0.00" appears in X window, Y window by moving the machine table whether in ALE or in SDM coordinate.

STEPS:

1. Set the center of rectangular point O as the datum of ALE  
Make line AB parallel with X axis; line AD parallel with Y axis.  
When position lathe tool to point O  
Zero X axis and Y axis in SDM 000;  
Zero X axis and Y axis in SDM 001;  
Zero X axis and Y axis in SDM 002;  
Zero X axis and Y axis in SDM 003;

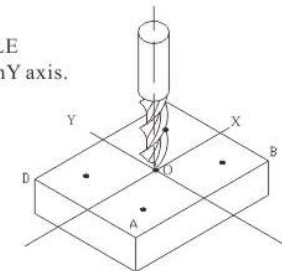

2. Set the point E as the datum of SDM 000.  
SDM 000: align the lathe tool with point E and zero X axis, Y axis. DRO displays as the right.





Press  $X_0$ ,  $Y_0$

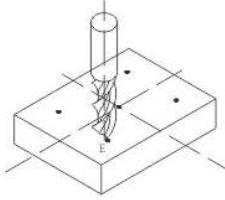

$X$  000000 SDM 000  
 $Y$  000000

3. Set the point F as the datum of SDM 001.  
 In SDM 001 and align the lathe tool with point F, then zero X axis, Y axis. DRO displays as the right:

Press  $X_0$ ,  $Y_0$

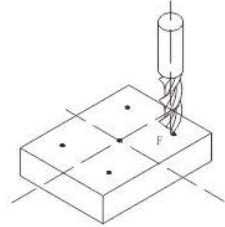

$X$  0060000 SDM 001  
 $Y$  -0045000

4. Set the point G as the origin of SDM 002.  
 In SDM 002, align the lathe tool with point G, and zero X axis, Y axis. DRO displays as the right.

Press  $X_0$ ,  $Y_0$

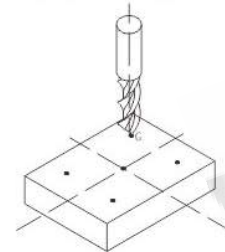

$X$  0060000 SDM 002  
 $Y$  0045000

5. Set the point H as the origin of SDM 003.  
 In SDM 003, align the lathe tool with point H, and zero X axis, Y axis. DRO displays as the right.

Press  $X_0$ ,  $Y_0$

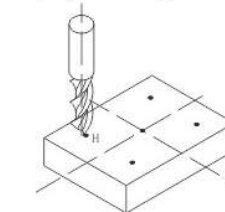

$X$  0060000 SDM 003  
 $Y$  -0045000

6. Machine the work-piece according to the preset SDM coordinate;

7. Machine another work-piece according to the same blueprint. You only need set the center point as the datum of ALE. It is not necessary to set SDM coordinate again, as SDM can be set automatically. Point E, F, G, and H is the zero point of SDM 000, SDM 001, SDM 002, and SDM 003 respectively. Point can be machined when enter corresponding SDM coordinate and "0.000" appears in screen by moving machine table. This function can save great plenty of time In production.

### 3.2 Preset datum of SDM Coordinate

Compared with the way of zeroing at current point, the another way (presetting datum of SDM coordinate) can set zero point of SDM more accurately and quickly without moving the machine table.

As the figure showed right, center point is the datum of ALE, the position of point E, F, G, H is (-60, -45), (60, -45), (60, 45), (-60, 45) in ALE coordinate.

- A Enter SDM 000 and preset the position of point O as (60, 45), which means the point E is the datum of SDM 000;
- B Enter SDM 001, preset the position of point O as (-60, 45), which means the point F is the datum of SDM 001;
- C Enter SDM 002 and set the position of point O as (-60, -45), which means the point G is the datum of SDM 002;
- D Enter SDM 003, preset the position of point O as (60, -45), which means the point H is the datum of SDM 003;

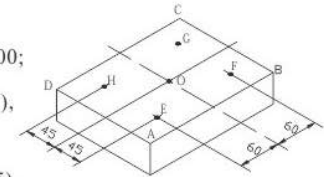

Pay attention that the preset value is negative to the actual value of position in ALE. If set "SDM DIR" as "1" in initial system settings, the caution is not necessary. The value DRO accepts is equal to the negative of the enter value.

#### STEPS:

1. Set "SDM DIR" as "1" in initial system settings;
2. Set the center point of the work-piece as the datum of ALE; Line AB is parallel to X axis, line AD is parallel to Y axis. Move machine table; align the milling cutter with point O. The machine table remain still while presetting;

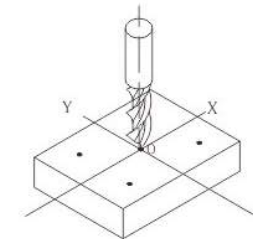

$X$  000000 ALE 0000  
 $Y$  000000

- 3 Set point E as the datum of SDM 000;  
 Enter SDM 000.  
 The position of point E is (-60, -45), press.



3 Set point E as the datum of SDM 000;

Enter SDM 000.

The position of point E is(-60,-45), press.

X 6 0  $\frac{\text{Z}}{\text{Z}}$  ENTER in turn  
Y 4 5  $\frac{\text{Z}}{\text{Z}}$  ENTER in turn



X 00060000 SDM 000  
Y 00045000

4. Set point F as the datum of SDM 001;

Enter SDM 001.

The position of point F is (60,-45), press

X 6 0 ENTER in turn  
Y 4 5  $\frac{\text{Z}}{\text{Z}}$  ENTER in turn



X 00600000 SDM 001  
Y 00045000

5. Set point G as the datum of SDM 002;

Enter SDM 002.

The position of G is(60,45), press

X 6 0 ENTER in turn  
Y 4 5 ENTER in turn



X 00600000 SDM 002  
Y 00045000

6. Set point H as the datum of SDM 003;

Enter SDM 003

The position of point H is(-60,45), press

X 6 0  $\frac{\text{Z}}{\text{Z}}$  ENTER in turn  
Y 4 5 ENTER in turn



X 00060000 SDM 003  
Y 00045000

## Chapter 4 SPECIAL FUNCTIONS

XH series DRO has special function as the following except measuring and positioning:

Bolt Hole Circle(BHC);

Bolt Holt Line(BHL);

ARC Processing(only for XH-Series);

Slope Processing (only for XH-Series);

Electrode discharging machining(EDM,only for XH Series);

Please refer **Coordinate System** (in Chapter 1)before reading this section.

### 4.1 Bolt Hole Circle

Functiondescription:

XH series DRO has the function of BOLT HOLE CIRCLE (BHC). This function can simplify the pressing of multiple holes which are attributed equally around the circumference of a circle. The DRO will guide operator to enter the following parameters:

|           |  |
|-----------|--|
| RADIUS    | Radius of circle   |
| ST.ANGLE  | Starting angle that the center of the first hole on the circle |
| END.ANGLE | Ending angle that the center of the last hole on the circle    |
| HOLE NUM  | Hole number  |
| DIRECT    | Angle direction.   |

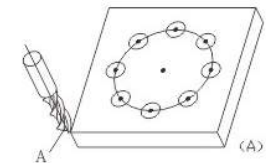

Angle has two directions: counterclockwise and clockwise. "0" indicates that it is counterclockwise from ST.ANGLE to END.ANGLE; "1" indicates it is clockwise from ST.ANGLE to END.ANGLE. As the following figure, the ST.ANGLE is 0°, END.ANG is 240°. The figure(B) illustrates the arc while angle direction is counterclockwise; figure(C) illustrates the arc while angle direction is clockwise.

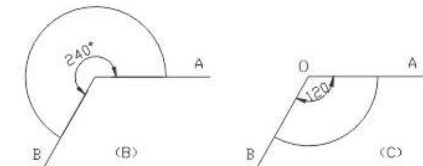

As figure (D) illustrates, machine a hole every 45 deg from 0°~225°. Parameters are as the following:

|           |     |
|-----------|-----|
| RADIUS    | 20  |
| ST.ANGLE  | 45  |
| END.ANGLE | 225 |
| HOL NUM   | 5   |
| DIRECT    | 0   |

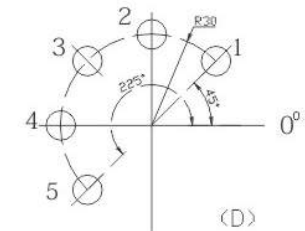

**NOTE:** If ST.ANGLE equals END.ANGLE, the holes are attributed equally around the whole circumference.

The positions of the hole center are calculated automatically after input all parameters.

Press  $\downarrow$  or  $\uparrow$  to choose the hole No. and move the machine table until the "0.000" appears in X window, Y window. It is the position to process a hole.

Example: Machine holes on circumference as the figure (E).

RADIUS 20mm  
 ST.ANGLE 0°  
 END.ANGLE 300°  
 HOLE NUM 6  
 DIRECT 0

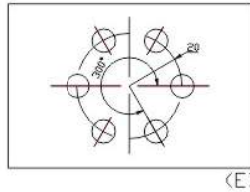

STEPS:

1. Set display unit to metric in normal state;  
 Move the machine table until the machine tool is aligned with the center of the circle, then zero X axis, Y axis.

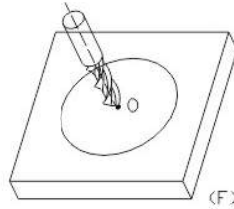

2. Press to enter Bolt Hole Circle function.

If all parameters have been set, press to process directly.

3. Input radius

Y window displays the formerly preset radius; message window displays "RADIUS". Press in turn.

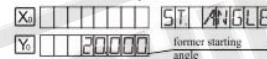
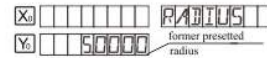

NOTE:

If "0" is inputted as the radius, the DRO will be requested to input again.

If incorrect parameter has been input and you haven't pressed , press to cancel and input again; if you have pressed and begin to set another parameter, you should press to return RADIUS set and input again. Other parameters can be dealt with in the same way.

4. Input ST.ANGLE

Message window displays "ST.ANGLE"; Y window displays the former preset starting angle.

Press in turn;

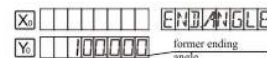
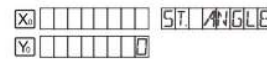

5. Input ending angle

Message window displays "END.ANGLE"; Y window displays the former angle.

Press in turn.



6. Input the number of hole.

Message window displays "HOLE NUM"; Y window displays the former number.

Press in turn.

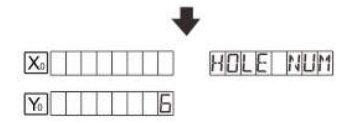

NOTE: If "0" or "1" is inputted as the number of holes, the DRO will point out this mistake and remind inputting again.

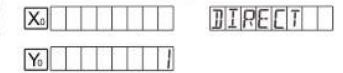

7. Input angle direction.

Message window displays "DIRECT", Y window displays the former preset direction;

Press in turn;

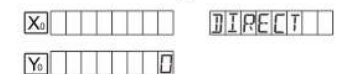

8. Message window displays "HOLE 1";

It is the position of the first hole to punch where the "0.000" is displayed in X window and Y window by moving the machine table.



9. After finishing the first hole, press .

Message window displays "HOLE 2";

Move the machine table, the "0.000" is displayed in X window and Y window. It is the position of the second hole.



NOTE: Press or to change holes number.



10. Process the holes 3rd -6th in the same way.

11. After processing all holes, press to return normal display state.

NOTE: In the course of BOLT HOLE CIRCLE processing, pressing (three axes display) or (two axes display) can leave BOLT HOLE CIRCLE function temporarily and return normal display state in order to check the position. And press (three axes display) or (two axes display) again to return BOLT HOLE CIRCLE function.

## 4.2 Bolt Hole Line

Function: XH series DRO provides BOLT HOLE LINE(BHL) function. This function can simplify the processing multiple holes whose centers are attributed equally on one line.

The following parameters are needed to be input:

LINE DIS Line distance (distance between the center of first hole and the center of the last hole)

LINE ANG Line angle (angle between the line and the positive X axis)  
 HOLE NUM Number of holes

DRO will calculate the positions of the hole after all the parameters have been entered. Press or to select the No. of hole and move the machine until "0.000" is displayed in X window and Y window. It is the position of hole to machine.

Example:  
 LINE DIS 150mm  
 LINE ANG 30°  
 HOLE NUM 6

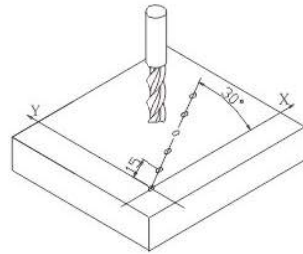

STEPS:

1. Set display unit to metric and the shrinkage is not taken into consideration.

Move the machine table until the machine tool is aligned with the center point of the first hole, and zero X axis, Y axis.



2. Press to enter BOLT HOLE LINE function; If all parameters have been entered, press to start processing directly.



3. Input line distance.  
 Y window displays the former preset line distance, and the message window displays "LINE DIS".  
 Press in turn;



**NOTE: If "0" is input as the line distance: the DRO will not accept and remind the operator to input again.**

4. Input line angle.  
 The message window displays "LINE ANG"; Y window displays the former preset line angle.  
 Press in turn.

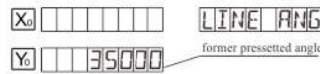

5. Input the number of hole.  
 Message window displays "HOLE NUM", Y window displays the former preset hole number.  
 Press in turn, processing begins.

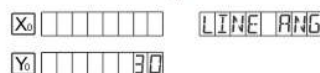

**NOTE: If "0" or "1" is input as hole number, DRO will not accept and remain user to input again.**

6. Message window displays "HOLE 1";  
 Move the machine table until "0.000" appears in Xwindow and Y window, it is the center of the first hole to punch.

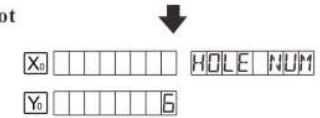

7. After finishing the first hole, press , and the message window displays "HOLE 2";  
 Move the machine table until "0.000" appears in X and Y window, and then you can punch the second hole at this point.

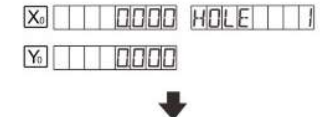

**NOTE: Press or to transform among holes.**

8. Process the holes 3rd-6th in the same way.

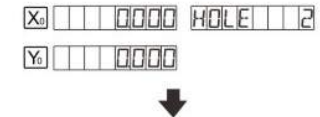

9. Press to return normal display state when finishing processing.

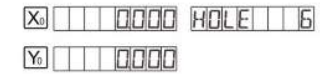

**NOTE:**

In the course of BHL processing, you can press (three axes display) or (two axes display) to leave this function temporarily and return normal display of X, Y, Z axis in order to check the position which the DRO calculated. Then press (three axes display) or (two axes display) again to return BHL function.

### 4.3 ARCProcessing

This function is only for XH Series.

It is wasteful to use numerical control lathe to process arc in the simple product or small production. This function makes it convenient to process arc with normal lathe. Parameter "MAX CUT" is the arc length each process. The smaller the MAX CUT, the more smooth the arc plane and the longer processing time.

#### A. Process XZ, YZ plane

There are 8 modes as the following when processing arc in XZ or YZ plane:



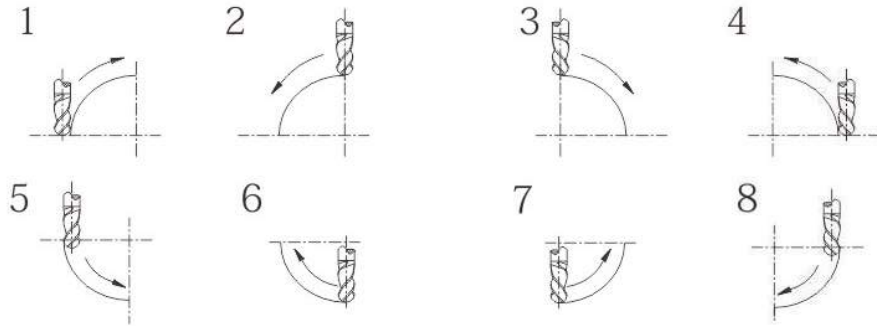

Milling cutter may be flat-bottomed or arc-bottomed. If flat-bottomed, set the tool diameter as 0;

**B. Process XY plane**

DRO provides the above 8 modes in processing XY plane. The milling cutter is perpendicular to the machine plane. DRO has internal ARC processing and external ARC processing for each type:

- External T+TOOL:
- Internal T-TOOL.

Set the tool radius according to the actual milling cutter when process XY plane.

Tool compensation direction (when process XY plane)

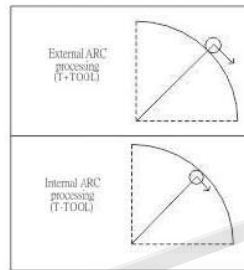

Enter the following data for ARC processing:

|                   |   |
|-------------------|---|
| TYPE 1-8          | Mode of the ARC processing  |
| * T+TOOL / T-TOOL | Selection between T+TOOL/T-TOOL (This parameter is only for XY plane) |
| RADIUS            | The radius of ARC that is to be processed                             |
| TOOL DIA          | Tool diameter   |
| MAX CUT           | Feed step   |

**Example 1:**

Process an arc AB of 90° from point A to point B as the figure.

Parameters are as the following:

|               |       |
|---------------|-------|
| Machine plane | XY    |
| ARC mode type | 3     |
| T+TOOL        |       |
| RADIUS        | 20mm  |
| TOOL DIA      | 6mm   |
| MAX CUT       | 0.5mm |

Shrinkage is not taken into consideration.

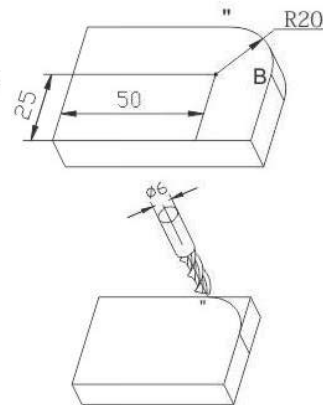

**STEPS:**

1. Set display unit is metric, and the LED of the shrinkage is off.
2. Move the machine table until the lathe tool is aligned with point A, then zero X axis and Y axis;
3. Enter ARC processing state; Press **[F2]** to enter ARC processing state. If all parameters have been set: press **[ENTER]** to process directly.
4. Select machine plane; Press **[X]** **[ENTER]** to select XY.

**NOTE:** **[X]** indicates XY plane;  
**[Y]** indicates YZ plane;  
**[Z]** indicates ZX plane;

You can also press **[F2]** (two axes display) or **[F3]** (three axes display) to switch plane among XY plane, YZ plane and ZX plane.

5. Select processing mode: Message window displays -TYPE 1"8", and Y window displays the former processing mode; Press **[3]** **[ENTER]** in turn to select mode 3, and then enter ARC type;
6. Select T+TOOL mode: Press **[+]** **[ENTER]** to select the external arc processing;

**NOTE:** **[+]** indicates T+TOOL mode (external arc processing);  
**[-]** indicates T-TOOL mode (internal arc processing).

7. Set ARC radius: Message window displays "RADIUS", and Y window displays the former arc radius; Press **[2]** **[0]** **[ENTER]** in turn to input the arc radius.

**NOTE:** If "0" as the arc radius is input: the DRO will display error message and wait another number.

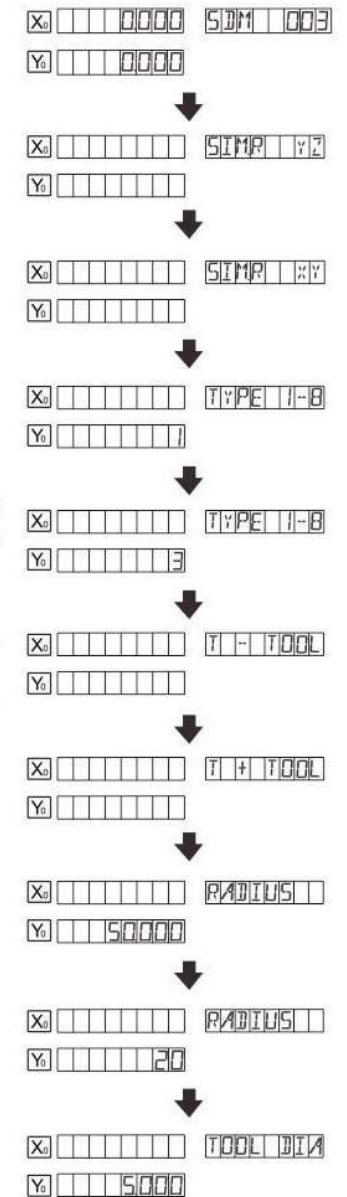

8. Set Tool diameter.

Message window displays "TOOL DIA";  
Y window displays the former preset diameter  
Press **6** **ENTER** in turn to enter the tool diameter.

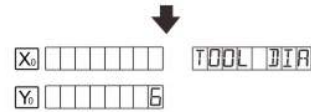

9. Set the feed step.

Message window displays "MAX CUT";  
Y window displays the former feed step.  
Press **0** **.** **5** in turn to input the feed step.

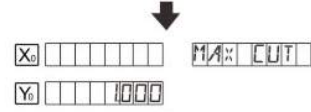

**NOTE: If "0" is inputted as the feed step, the DRO will not accept and wait for inputting another data.**

10. Process ARC

Message window displays "POIN 1". Process when the "0.000" appears in X window and Y window. Then you have finished the first point. Press **↓** to switch to the second point and repeat the same step. Process in this way until the message window displays "POIN 74". Pressing **↑** or **↓** can select processing point.

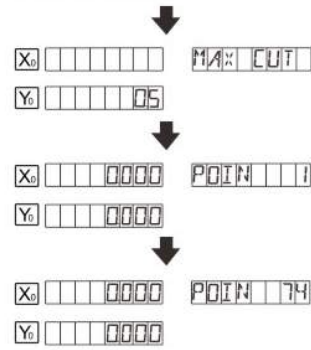

11. Press **EXIT** to exit ARC processing after machining is over.

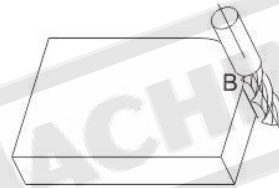

**NOTE:**

- In the ARC process, pressing (three axes display) or (two axes display) can leave this function temporarily to return normal display of X, Y, and Z axis in order or check the position the DRO has calculated. Press (three axes display) or (two axes display) to return ARC function.
- Processing **↑** or **↓** can switch among the parameters in the course of the presetting parameter.

Example 2:

Process the ARC EF as the figure from point E to point F.  
Parameters are set as following:  
Machine plane: XZ  
TYPE: 4  
RADIUS: Actual radius of the arc  
TOOL DIA: 0 (flat-bottomed tool)  
MAX CUT: preset as the customer

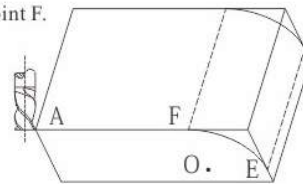

Example 3:

Process the ARC DE as the figure from point D to point E.  
E. Parameters are as the following:

Machine plane: XZ  
TYPE: 6  
RADIUS: Actual radius of the arc  
TOOL DIA: Actual value (actual tool)  
MAX CUT: preset as the customer

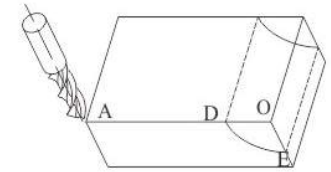

Example 4:

Process the ARC DE as the figure from point D to point E.

Parameters are as the following:  
Machine plane: YZ  
TYPE: 7  
RADIUS: Actual radius of the arc  
TOOL DIA: Actual value (actual tool)  
MAX CUT: preset as the customer

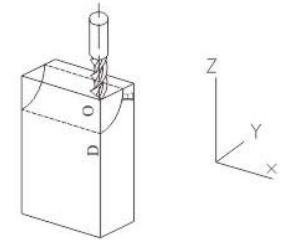

**Note:** For XH Series, it is not installed with Z-axis, please press **↑** or **↓** to simulate position of Z-axis, **↑** simulate moving to the former process point, and **↓** simulate moving to the next process point.

Steps:

1: set "STEPMODE" as "Z STEP" in setup mode, and set Z-axis dial (default value is 2.5mm);

2: Before machining, at first, align lathe with the beginning point Z of R, zero Z axis;

3: In machining process, message window displays simulate height of Z axis, which indicates simulate height of Z axis while machining;

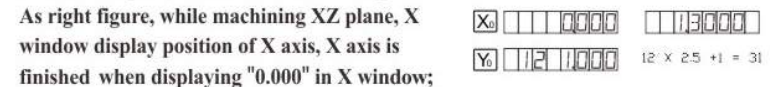

As right figure, while machining XZ plane, X window display position of X axis, X axis is finished when displaying "0.000" in X window;  
In Y window, the former 2 number indicates number of dial, and the following 5 number indicates scale number of dial, which means that machining to this scale for current point.

While machining YZ plane, Y window display position of Y axis, and when this window displays "0.000", which indicates the machining is finished in Y direction; In X window, the former 2 number indicates number of dial, and the following 5 number indicates scale number of dial, which means that machining to this scale for current point.

4.4 Slope Processing

This function is only for XH Series.

Function: This function can calculate the position of every processing point automatically in processing slope. Only the following parameters need to be inputted:

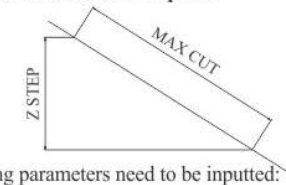



INCL: Set machine plane XY, YZ or XZ plane  
 INCL.ANG: the inclination angle of the slope  
 MAX CUT: the slope length each time processing

**Note:**  
 Z STEP and MAX.CUT are defined as the figure.

DRO will calculate the position of each processing on the slope automatically when all parameters have been input.

Press or to select the processing point and process until "0.000" appears in the window.

Example 1:

Process the slope AB as the figure. The parameters are as following:

INCL: XZ  
 INCL.ANG 45°  
 MAX. CUT 1.2mm

STEPS:

1. Set display unit to metric;  
 Set the S LOPMODE 1 in initial system settings.

**Note:** If the third parameter isn't Z STEP, set the SLOP.MODE 0.

Move the machine table until the lathe tool is aligned with the starting point A, then zero X axis and Z axis.

Press , in normal display state.

2. Press to enter slop processing  
 Press to start processing directly if all parameter have been set.

3. Select machine plane.  
 Press in turn to select the XY plane.

**Note:** Press indicates XY plane;  
 Press indicates YZ plane;  
 Press indicates ZX plane;

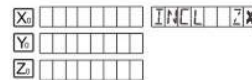
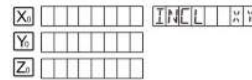
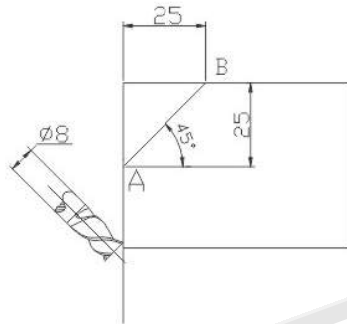
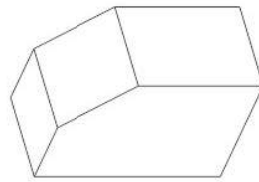

You can also press (two axes display) or (three axes display) to switch among XY plane, YZ plane or ZX plane.

4. Enter INCL.ANG.  
 Message window displays "INCL ANG"; Y window displays the former INCL.ANG.

Press , , in turn.

5. Enter MAX.CUT.  
 Message window displays "MAX CUT"; Y window displays the former MAX.CUT.

Press , , , in turn;

**NOTE:** If "0" is inputted as MAX CUT, DRO will not accept and wait for another data.

6. Processing  
 Message window displays "POIN 1";  
 Process slope when the "0.000" appears; then press to process the next point.

7. Press or to select point.

8. Press to return normal display state after processing is over.

**Note:** For XH Series, it is not installed with Z-axis, please press or to simulate position of Z-axis, simulate moving to the former process point, and simulate moving to the next process point.

Steps:

- 1: Set Z axis dial in internal system setup;
- 2: Before machining, align the start point Z point with lathe, then set Z axis as "0.000";
3. While machining XZ plane, X window display position of X axis, X axis is finished when "0.000" appears in X window; In Y window, the former 2 number indicates number of dial, and the following 5 number indicates scale number of dial, which means that machining to this scale for current point.  
 While machining YZ plane, Y window display position of Y axis, and when this window displays "0.000", which indicates the machining is finished in Y direction; In X window, the former 2 number indicates number of dial, and the following 5 number indicates scale number of dial, which means that machining to this scale for current point.

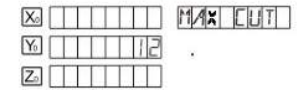
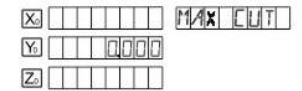
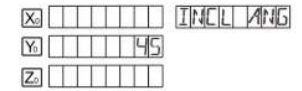
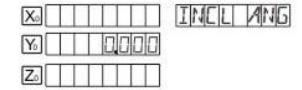



In slope processing, operator can press (three axes) or (two axes) to exit, return to normal display, making use of this you can confirm position of DRO. And then press (three axes) or (two axes) return to slope processing.

### 4.5 Auto Edge Detection

Function:

- > Searching border automatically;
- > Measuring dimension of work-piece;
- > Searching for the center of work-piece.

**NOTE:** This is an additional function. It needs additional pay.

Example:

Radius of EDGE DETECTOR            5 mm  
 Work-piece dimension on X axis    65 mm  
 Measure by using the linear scale installed at X axis.

STEPS:

1. Set display unit to metric.
2. Press (three axes display) or (two axes display) to enter AUTO EDGE DETECTION. Message window displays "SEL AXIS"; Y window displays the radius of the edge detector; the sign of the value displayed is the sign when the detector touches the first edge.
3. Input the radius and sign of the detector.  
 Press in turn, and then the Y window displays "-5.000".

X  SEL AXIS  
 Y  1000  
 Z

X  SEL AXIS  
 Y  -5000  
 Z

**NOTE:** You can skip this step if the diameter is set well.

4. Select axis, take X axis for example.  
 Press to select X axis.  
 "0.000" flashes in X window, waiting for detecting edge.  
 Y window, Z window display the value of the current position.  
 Press to select Y axis; press to select Z axis in the same way.

X  0000 SCH 00  
 Y  20000  
 Z  30000

5. Move the EDGE DETECTOR to touch the first edge, then the X window will display the position of the detector with "-5.000". The displayed value in X window is the measure value. You can touch the edge many times.

X  -5000 SCH 00  
 Y  20000  
 Z  30000



6. Move the EDGE DETECTOR to touch another edge. The X window will show the length of the work-piece with "65.000";

X  65000 SCH 00  
 Y  20000  
 Z  30000

7. Press to exit this function. Move the EDGE DETECTOR until the X window displays "0.000", which means that this position is the center of the work-piece at the X axis direction.

**NOTE:** 1. Pressing (three axes display) or (two axes display) will exit this function when in EDGE DETECTION function.

2. If you detect edge only, you needn't do step 6 and 7.
3. If do not find the center point, you needn't do step 7.

## Chapter 5 EDM (ELECTRICAL DISCHARGE MACHINING)

Note: Only XH Series provides EDM function.

DRO will send out a signal and machining will stop as soon as the display value is equal to the expectant .

XH series is equipped with 7 EDM modes:

- MODE 1 manual mode 1
- MODE 2 automatic mode 1
- MODE 3 manual mode 2
- MODE 4 manual mode 3
- MODE 5 manual mode 4
- MODE 6 automatic mode 2
- MODE 7 automatic mode 3

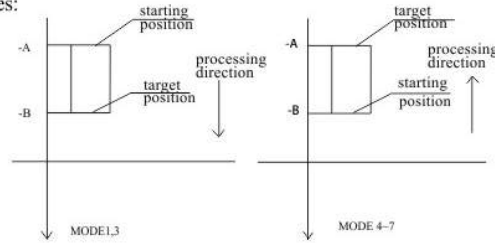

Fig 1 : Difference among EDM modes

EDM mode is set in initial system settings.

NOTES: Pay attention to the relay mode.

Table 1: the difference between 7EDM modes:(X:Nohave;√:Have; ↑ :Up; ↓ :Down)

| EDM MODE | Edge detect | Direction of machining as depth is minus | Exit EDM after machine first hole | Z axis direction |
|----------|-------------|--|-----------------------------------|------------------|
| 1        | X           | ↓  | √                                 | ↓                |
| 2        | √           | No minus depth                           | X                                 | ↓                |
| 3        | X           | ↓  | X                                 | ↓                |
| 4        | X           | ↑  | √                                 | ↓                |
| 5        | X           | ↑  | X                                 | ↓                |
| 6        | √           | ↓ (No plus depth)                        | X                                 | ↑                |
| 7        | √           | ↓  | X                                 | ↑                |

Positive direction of Z axis is down except mode 6: which means the display value will increase with the increasing depth during machining.

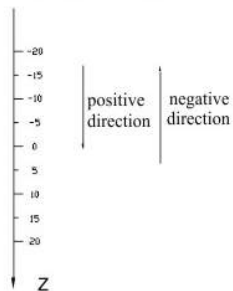

Fig 2

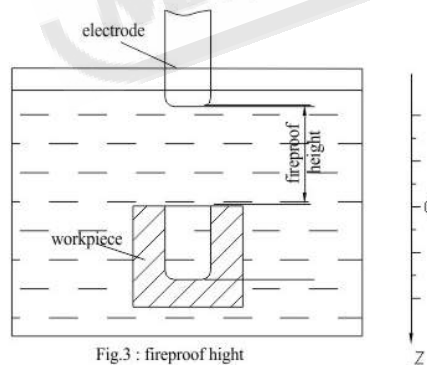

Fig.3 : fireproof hight

XH Series provides fireproof function. During EDM, charcoal will be produced on the machined surface. With accumulating charcoal, the electrode will be beyond liquid level, which could lead a fire. If fireproof height is set, EDM will stop, the DRO will send an alarm and fire is avoided.

### 5.1 Setting EDM Parameters

The following parameters must be set before EDM is done:

- A Depth of machining (EDM D EEP)
- B Fireproof height (EDM HOME)
- C Electrode compensation (EDM.COMP if DEEP COMP is active)
- D EDM mode (EDM M ODE)
- E Relay mode (RELAY MODE)
- F Disable/Enable electrode compensation (D EEP.COMP)

A, B, C can be set by pressing in normal display state; D, E, F can be set in initial system settings, and they are modified rarely. If the DEEP.COM is set as op, electrode compensation is not taken into consideration; if it is set as of, the value of electrode compensation can be set in parameter setting, and electrode compensation should be taken into consideration during machining.

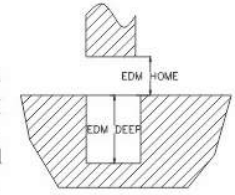

Fig.4 : EDM.DEEP

Example:

- EDM depth (EDM D EEP) 156.1mm
- Fireproof height (EDM HOME) 3.0mm
- Electrode compensation (EDM.COMP) 0.1mm

STEPS:

1. Set EDM COMP as 01p in initial system settings to enable electrode compensation;

2. Return normal display state, and then set display unit is to metric;

3. Input EDM parameters.

Press , the Y window displays the former depth; Input depth by pressing **1 5 6 . 1** **ENTER** in turn;

4. The Y window displays the former fireproof height; Input the fireproof height.

Press **3** **ENTER** ;

5. The Y window displays the value of former electrode compensation;

Input the new value.

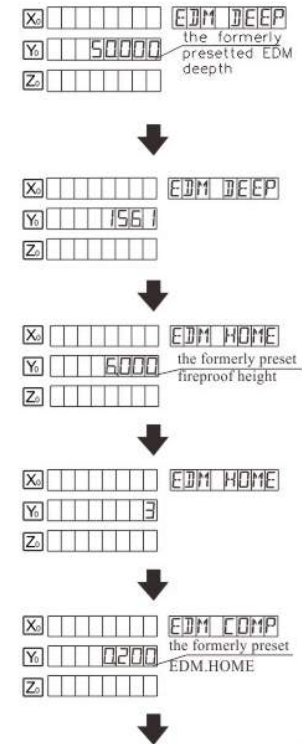

Press **0** **.** **1** **ENTER** in turn;

6: Press **STOP** to return normal display state.

```

X [ ] [ ] [ ] [ ] [ ] [ ] [ ] [ ] EDM COMP
Y [ ] [ ] [ ] [ ] [ ] [ ] [ ] [ ]
Z [ ] [ ] [ ] [ ] [ ] [ ] [ ] [ ]

↓

X [ ] [ ] [ ] [ ] [ ] [ ] [ ] [ ] EDM COMP
Y [ ] [ ] [ ] [ ] [ ] [ ] [ ] [ ]
Z [ ] [ ] [ ] [ ] [ ] [ ] [ ] [ ]
  
```

## 5.2 EDM machining

Return normal display state; then press **START** to start machining after all EDM parameters have been set. XH series provides 6 EDM modes to deal with different requirements.

### 5.2.1 Example for Mode 1 with plus depth

Process a work piece as figure (a): Z axis positive direction is down. Parameters are as following:

|          |         |
|----------|---------|
| EDM DEEP | 20 mm   |
| EDM HOME | 5mm;    |
| EDM COMP | 0.1 mm; |

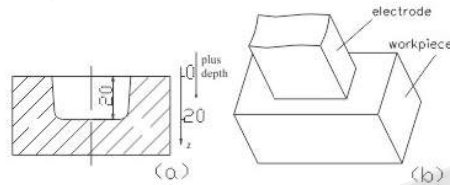

STEPS:

- Set the following parameters in initial system settings;
  - EDM MODE is set as 1;
  - RELY.MODE is set as 0;
  - DEEP.COMP is set as 1, which means the DEEPCOMP is active;
- Return normal display state with the following settings;
  - Display unit is metric;
  - Shrinkage is not taken into consideration;
- Set parameters in EDM function:
  - EDM.DEEP 20mm
  - EDM.HOME 5mm
  - EDM.COMP 0.1mm;

- Move the electrode until it touches the machining plane, as figure (b).

Press **Z0** to zero Z axis display value;

```

X [ ] [ ] [ ] [ ] [ ] [ ] [ ] [ ] EDM RUN
Y [ ] [ ] [ ] [ ] [ ] [ ] [ ] [ ] start machining
Z [ ] [ ] [ ] [ ] [ ] [ ] [ ] [ ]
  
```

- Starting machining.

Press **START**, X window displays the expectant = EDM.DEEP + EDM.COMP, Y window displays the current machined depth,

```

X [ ] [ ] [ ] [ ] [ ] [ ] [ ] [ ] EDM RUN
Y [ ] [ ] [ ] [ ] [ ] [ ] [ ] [ ] in machining
Z [ ] [ ] [ ] [ ] [ ] [ ] [ ] [ ]
  
```

Z window displays the current position of electrode, Message window displays "EDM RUN";

- When Z window displays value = EDM.DEEP + EDM.COMP = 20.1, the buzzer will sound and message window will display "BACKWARD", and then the machining stops and the electrode withdraws.

The actual machined depth is 20mm when Z window displays value = EDM.DEEP + EDM.COMP = 20.1 because of electrode wear.

During electrode withdrawing, Z window displays the current position of electrode, X window displays the preset value (EDM.DEEP + EDM.COMP), Y window displays the formerly preset depth;

The DRO will quit EDM and return normal display state when the electrode withdraws higher than the fireproof height; The DRO will exit EDM automatically if the electrode doesn't withdraw in 25 seconds.

The LED of **STOP** will flash if EDM.COMP is active during machining; Pressing **STOP** can exit EDM in the course of EDM machining;

**Note:** In the course of EDM, by pressing **STOP** or **STOP**, the operator can temporarily quit EDM function and return normal display state in order to watch the position of X, Y, Z axis. Press **STOP** or **STOP** again to return EDM function.

### 5.2.2 Example for Mode 1 with Minus Depth

Machine the work-piece as figure (c), Z axis positive direction is down. Parameters as following:

Parameters as following:  
EDM.DEEP -20 mm;  
EDM.HOME 55mm;

STEPS:

- Set the following parameters in initial system settings;
  - EDM MODE is 1;
  - RELY.MODE is 0;
  - DEEP.COMP is 0, electrode compensation is disabled;

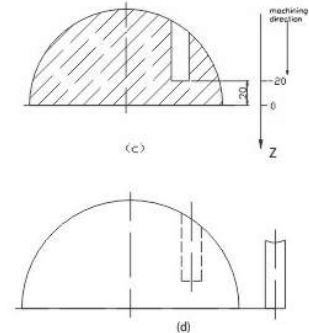

```

↓

X [ ] [ ] [ ] [ ] [ ] [ ] [ ] [ ] EDM RUN
Y [ ] [ ] [ ] [ ] [ ] [ ] [ ] [ ] end machining
Z [ ] [ ] [ ] [ ] [ ] [ ] [ ] [ ]

↓

X [ ] [ ] [ ] [ ] [ ] [ ] [ ] [ ] BACKWARD
Y [ ] [ ] [ ] [ ] [ ] [ ] [ ] [ ] electrode begin withdrawing
Z [ ] [ ] [ ] [ ] [ ] [ ] [ ] [ ]

↓

X [ ] [ ] [ ] [ ] [ ] [ ] [ ] [ ] BACKWARD
Y [ ] [ ] [ ] [ ] [ ] [ ] [ ] [ ] electrode in withdrawing
Z [ ] [ ] [ ] [ ] [ ] [ ] [ ] [ ]

↓

X [ ] [ ] [ ] [ ] [ ] [ ] [ ] [ ] SUM 1000
Y [ ] [ ] [ ] [ ] [ ] [ ] [ ] [ ]
Z [ ] [ ] [ ] [ ] [ ] [ ] [ ] [ ]
  
```



2. Return normal display state with the following settings:

- Display unit is metric;
- Shrinkage is not taken into consideration;

3. Set the parameters in EDM function;

- EDM.DEEP -20mm
- EDM.HOME 55mm

4. Move the electrode until it touches the machining planes as figure (d),

Press **Z0** to zero z axis;

Move the electrode to the position as figure (e).

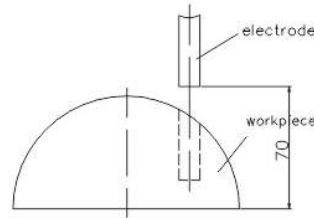

(e)

5. Starting EDM.

Press **F1**,

X window displays the expectant = EDM.DEEP + EDM.COMP,

Y window displays the current machined depth;

Z window displays the current position of the electrode,

Message window displays "EDM RUN";

6. When Z axis displays the value = EDM.DEEP = -20.000, the buzzer sounds, message window displays "BACKWARD". Then the machining stops and the electrode withdraw;

During withdrawing the electrode, Z window displays the current position of the electrode, X window displays the preset EDM deep and Y window displays the machined depth;

The DRO will exit the EDM function and return normal display state if the electrode doesn't withdraw in 25 seconds;

The DRO will quit the EDM function when the electrode beyond the fireproof height (EDM.HOME).

Press **F1** to exit the EDM function during machining;

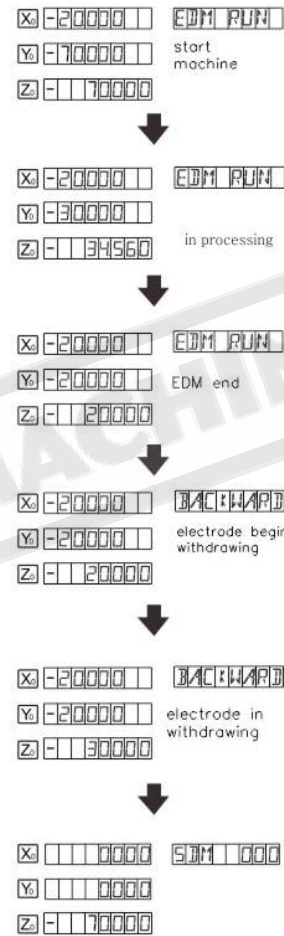

### 5.2.3 Example for Mode 2

DRO must be connected with the edge detector sensor. Press **F1** to enter EDM, Z axis is zeroed automatically and machining begins when the electrode touches the machining plane. As soon as process to the expected depth, the relay sends out a signal to withdraw the electrode and stop EDM machining. When the electrode beyond fireproof height, move the machine table to next hole to machine another hole without pressing **F1**. Mode 2 can process multiple holes conveniently.

Characteristics for MODE 2:

- The DRO connected with sensor which can detect edge and zero display value automatically.
- The DRO needn't exit EDM to machine next hole.
- EDM.DEEP can't be minus;
- Z axis positive direction and machining direction is down;
- The electrode waste is very small and negligible;

Process six holes in one work-piece as figure (f) Z axis direction is down.

Parameters are as following:

- A. EDM.DEEP 20.1 mm
- B. EDM.HOME 5mm;

Take the mode of detecting and zeroing Z axis automatically.

STEPS:

1. Set the following parameters in initial system settings:

- ① EDM MODE is set 2;
- ② RELY.MODE is set 0;
- ③ DEEP.COMP is set 0, electrode compensation is disabled;

2. Enter the normal display state with the following setting:

- ① Display unit is metric;
- ② Shrinkage is not taken into consideration;

3. Set parameters;

- ① EDM.DEEP 20.100mm
- ② EDM.HOME 5mm

4. Press **F1**, the DRO will display as the right.

5. By moving the electrode until it touched the machining plane, the z axis will be zeroed automatically.

6. Start EDM

X window displays the expectant = EDM.DEEP;

Y window displays the current machined depth;

Z window displays the current position of the electrode, Message window displays "EDM RUN";

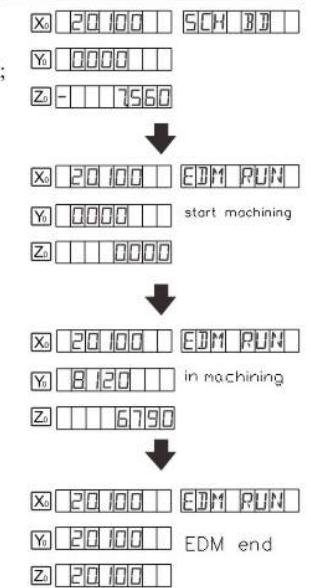
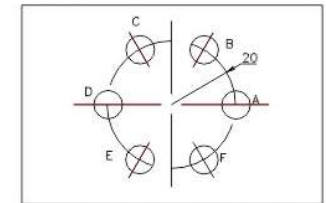



7. When the Z window displays value= EDM.DEEP= 20.1, the buzzer sounds and the message window displays "BACKWARD", and then the machining stops and the electrode withdraw;

During the electrode withdrawing:  
Z window displays the current position of the electrode;  
X window displays value=EDM.DEEP+EDM.COMP;  
Y window displays the formerly machined depth.

If the electrode doesn't exit in 25 seconds,the DRO will enter the steps to machine another hole by repeating steps 5-7.

If the electrode beyond the fireproof height (EDMHOME), the DRO will enter the steps to process another hole by repeating steps 5~7.

Press  to exit EDM when machining completes.  
Press  to exit EDM during machining.

**Note:** The LED for  flashes during machining if DEEP.COMP is enabled.

### 5.2.4 Example for Mode 3

Compared with Mode 1 Mode 3 hasn't the function of fireproof height. DRO can exit EDM only when the electrode goes down again. The datum will not change because z axis is not zeroed again to machine next hole. This mode is only used in case of the electrode waste is too small where waste to be neglected.

Process the work-piece as figure (F) in 5.2.3,Z axis direction is down;  
EDM.DEEP 20.100mm

STEPS:

- Set the following parameters in initial system settings;
  - EDM MODE is set 3;
  - RELY.MODE is set 0;
  - DEEP.COMP is set 0, depth compensation is disabled;
- Return normal display state with the following setting;
  - Display unit is metric;
  - Shrinkage is not taken into consideration
- Set parameters in EDM;
  - EDM.DEEP 20.100mm

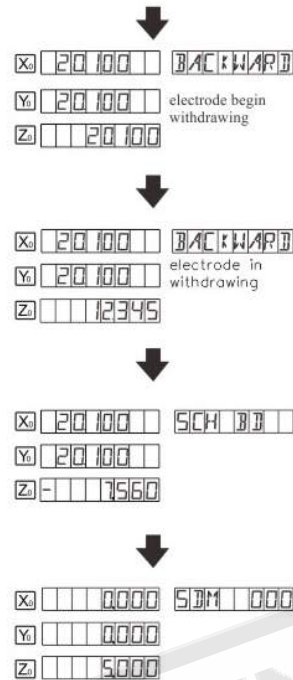



4. Move the electrode until it touches the machining plane as the figure (b), press  to zero z axes;

5. Start EDM. Press ,  
X window displays the expectant= EDM.DEEP=20.100,  
Y window displays the current machined depth;  
Z window displays the current position of electrode;  
Message window displays "EDM RUN";

6. When the Z window displays value= EDM.DEEP= 20.100 , the buzzer sounds and the message window displays "BACKWARD", then the machining stops and the electrode withdraws.

During the electrode withdrawing:  
Z window displays the current position of electrode;  
X window displays the preset EDM.DEEP;  
Y window displays the former machined depth.

Press  to process next hole by repeating the steps 5-6 if the electrode withdraws above datum.

7. Machining is finished, and the electrode goes back to a certain height. Press , MM axis display "EDM RUN".  
Press  to exit EDM.

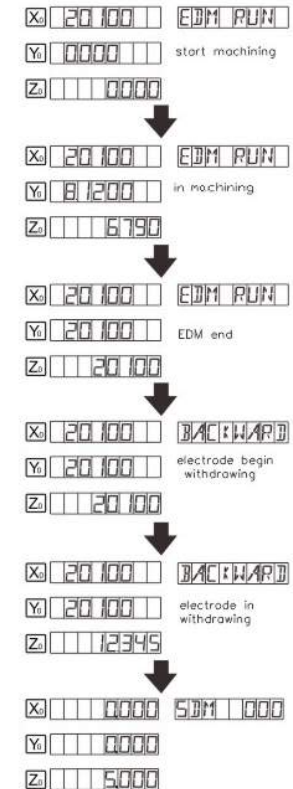

### 5.2.5 Example for Mode 4 with Minus Depth

MODE 4 has the same steps as MODE 1 and MODE 5 has the same steps as MODE 3. The difference between mode 4 and mode 1, mode 5 and mode 3 is the machining direction when the EDM.DEEP is minus. This difference is shown at table (1).  
Machine a work-piece as figure (G).

STEPS:

- Set the following parameters in initial system settings;
  - EDM MODE is set as 4;
  - RELY.MODE is set as 0;
  - DEEP.COMP is set as 0, which means DEEP.COM
  - P is disabled;
- Return the normal display state with the following

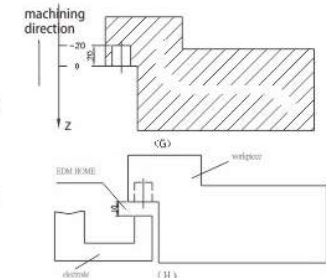



setting;

- Display unit is metric;
- Shrinkage is not taken into consideration.

3. Set the following parameters in EDM function;

- EDM.DEEP -20mm
- EDM.HOME 10mm

Height of withdrawing is defined as the figure(H)DRO will exit EDM if electrode is below EDM HOME.

4. Move the electrode until it touches the machining plane as figure(I).

Press **Z0** to zeroing Z axis;

5. Start EDM.

Press **F1**, then

X window displays the expectant = EDM.DEEP + EDM.COMP;

Y window displays the current machined depth;

Z window displays the current position of electrode

Message window displays "EDM RUN";

6. When the Z window displays the value = EDM.DEEP = -20.000, the buzzer sounds and the message window display "BACKWARD". Then the machining stops and the electrode withdraw.

During withdrawing electrode:

Z window displays the current position of electrode;

X window displays the preset EDM.DEEP;

Y window displays the former machined depth;

The DRO will quit EDM and return normal display state automatically if the electrode doesn't exit in 25 seconds.

The DRO will quit EDM function and return normal display state when the electrode withdraw exceeds the height of the withdrawing.

Press **F2** to quit during the machining;

**Note: Mode 5 and mode 4 is same if depth is minus. The step of mode 5 is same with mode 2.**

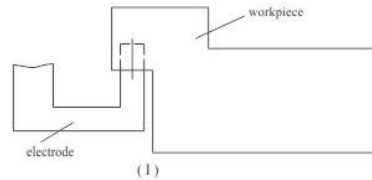

(1)

|   |        |                 |
|---|--------|-----------------|
| X | -20000 | EDM RUN         |
| Y | 00000  | start machining |
| Z | 10000  |                 |

|   |        |              |
|---|--------|--------------|
| X | -20000 | EDM RUN      |
| Y | -10000 | in machining |
| Z | -14560 |              |

|   |         |         |
|---|---------|---------|
| X | -20000  | EDM RUN |
| Y | -20000  | EDM end |
| Z | -120000 |         |

|   |         |                            |
|---|---------|----------------------------|
| X | -20000  | BACKWARD                   |
| Y | -20000  | electrode begin going back |
| Z | -120000 |                            |

|   |         |                |
|---|---------|----------------|
| X | -20000  | BACKWARD       |
| Y | -20000  | in withdrawing |
| Z | -110000 |                |

|   |         |         |
|---|---------|---------|
| X | 00000   | SDM 000 |
| Y | 00000   |         |
| Z | -110000 |         |

### 5.2.6 Example for Mode 6

The operate step and machined work-piece of MODE 6 is the same as MODE 2. The difference between them is Z axis positive direction: in MODE 2, the Z axis' positive direction is down, EDM.DEEP is plus when machining down; in MODE 6, the Z axis' positive direction is up, EDM.DEEP is minus when machining down.

The DRO must be connected with the sensor that can detect edge and zero Z axis' display value automatically. Pressing **F1** to enter EDM function, the display value of Z axis is zeroed and machining began when the electrode touches the machining plane. When the display value of Z axis equals to or larger than the expected depth, the relay sends out a signal to withdrawing the electrode; if the electrode beyond the fireproof height, move the machine table to next hole to machining another hole without pressing **F1**. Mode 6 can process multiple holes quickly.

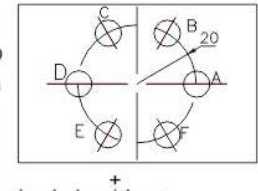

Running conditions for MODE 6:

- The DRO must be connected with the sensor of an electric edge detector if you want to use automatically detect edge function;
- The DRO doesn't exit EDM after one hole is machined;
- EDM.DEEP can't be plus;
- Z axis direction is up and machining direction is down;
- The electrode wear is very small and can be neglected;

Process six holes in one work-piece as figure (J), Z axis direction is up. Parameters are as following:

- EDM.DEEP 20 mm
- EDM.HOME 5mm;

STEPS:

1. Set the following parameters in initial system settings;
  - EDM MODE is set 6;
  - RELY.MODE is set 0;
  - DEEP.COMP is set 0: depth compensation is disabled;

2. Return normal display state with the following setting;

- The display unit is metric;
- Shrinkage is not taken into consideration.

3. Set the parameters in EDM function:

- EDM.DEEP 20.000mm
- EDM.COMP 5mm

4. Press **F1**, enter the EDM function.

5. The DRO displays as the right.

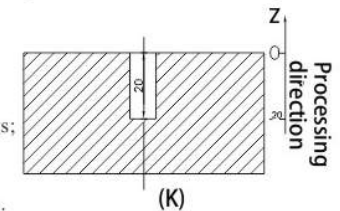

|   |        |         |
|---|--------|---------|
| X | -20000 | SCH 000 |
| Y | 00000  |         |
| Z | 17560  |         |

|   |        |                 |
|---|--------|-----------------|
| X | -20000 | EDM RUN         |
| Y | 00000  | start machining |
| Z | 00000  |                 |



Move the electrode until it touches the machining plane as figure (K);display value of z axis is zeroed automatically.

6. Start machining;

X window displays the expectant=EDM.DEEP;  
Y window displays the current machined depth;  
Z window displays the current position of the electrode;  
Message window displays"EDM RUN";

7. When Z window displays the value= EDM.DEEP= 20.000,the buzzer sounds and the message window displays"BACKWARD", and then the machining stops and the electrode withdraw.

During withdrawing electrode :

Z window displays the current position of the electrode;  
X window displays the preset value=EDM.DEEP+ EDM.COMP;  
Y window displays the formerly preset depth;

If the electrode doesn't exit in 25 seconds;the DRO will machine another hole by repeating steps 5~7.

When the electrode withdraw beyond fireproof (EDM.HOME),the DRO will machine another hole by repeating steps 5~7.

Press to quit EDM when machining completes.

Press to quit EDM during machining.

Note: The LED for flashes during machining if DEEP.COMP is enabled.

### 5.2.7 Example for Mode 7

The operate step and machined work-piece of MODE7 is alikeas MODE 5.The difference is that DRO must detect edgewise entering EDM function in MODE 7.

Processwork-piece as figure (f): Z axis direction is down. Parameters are as following:

- EDM.DEEP 20.100mm
- EDM.HOME 5.000mm;

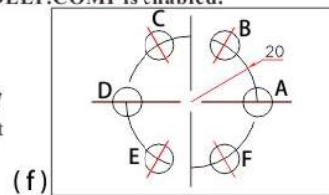
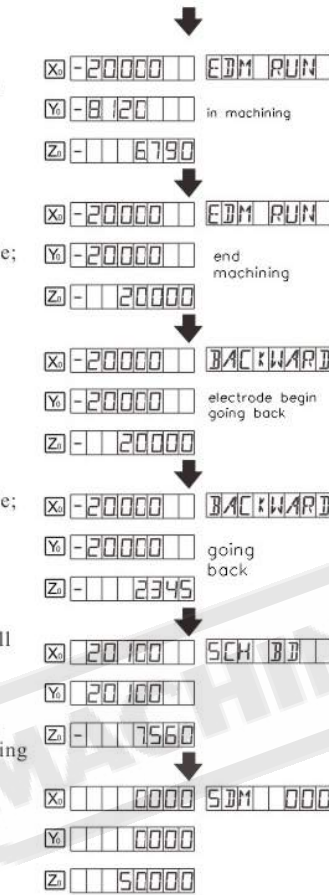

STEPS:

1. Set the following parameters in initial system settings;
  - EDM MODE is set 7;
  - RELY.MODE is set 0;
  - DEEP.COMP is set 0,depth compensation is disenabled;

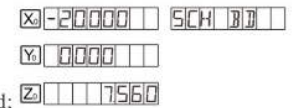

2. Return normal display state with the following setting;
  - The display unit is metric;
  - Shrinkage is not taken into consideration.

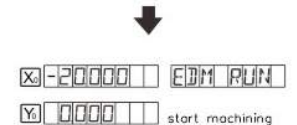

3. Set the parameters in EDM function:
  - EDM.DEEP20.100mm
  - EDM.COMP5mm



4. Press ,the DRO displays as the right.

Move the electrode until it touches the machining plane, display value of Zaxis is zeroed automatically.

Or you can zero the Z axis by press the key .

Press , X window displays the expectant = EDM.DEEP = 20.100,

Y window displays the current machined depth;

Z window displays the current position of the electrode;  
Message window displays "EDM RUN";

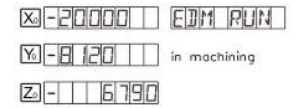

5. When Z window displays the value= EDM.DEEP= 20.100, the buzzer sounds and the message window displays"BACKWARD", and then the machining stops and the electrode withdraw.

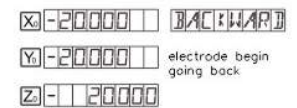

During withdrawing electrode :

Z window displays the current position of the electrode;  
X window displays the preset value = EDM.DEEP+ EDM.COMP;

Y window displays the formerly preset depth;



When the electrode beyond fireproof height (EDM.HOME), the message window displays "EDM RUN" and the DRO will machine the next hole by repeating steps4.



6. Press to quit EDM when machining completeswhich in Message window displays "EDM RUN".

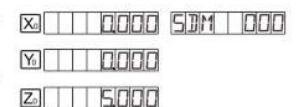

### 5.3 Combination of BHC:BHL and EDM Function

XH Series can use EDM to machine holes when in BHC or BHL function.

Example: Process 6 holes with depth of 20mm as the figure(L) showing.

#### STEPS:

1. Set the following parameters in initial system setting:

EDM.MODE = 1;

RELAY.MODE = 0;

EDM.COMP = 0;

2. Set EDM.DEEP= 20mm; EDM.HOME = 3mm;

3. Set point O as datum in user coordinate system;

4. Press  to enter BHC function and set parameters:

ST.ANGLE=0°;      END.ANGLE=0°;

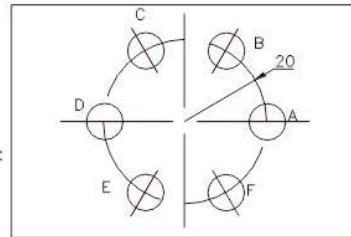

RADIUS=20mm;      HOLE.NUM=6;

DIRECTION=0;



5. After all parameter set, the message window will display "HOLE 1". Move the machine table until "0.000" displays in X, Y window; it is the position of point A. And then press  to enter EDM function to process hole A. After hole A is machined, DRO returns BHC.

6. Process hole B.

Press  and the message window will display "HOLE 2". Move the machine table until "0.000" displays in X, Y window; it is the position of point B. And then press  to enter EDM function to process hole B. After hole B is machined, DRO returns BHC.

7. Process hole C, D, E, F in the same way.

Press  to return normal display state when all holes finished.

Example 2: Process 6 holes with depth 10mm as the figure showing.

#### STEPS:

1. Set the following parameters in initial system setting:

EDM MODE = 1,

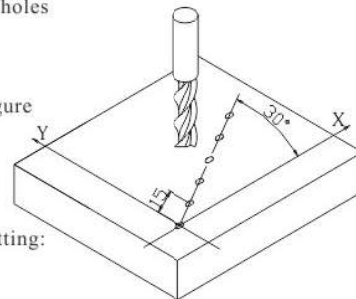



RELAY MODE = 0,

EDM COMP = 0;



2. Set EDM.DEEP 10mm; EDM.HOME 3mm;

3. Set the point O as datum for user coordinate system;

4. Press  to enter BHL function and set parameters:  
LINE.DIS=150mm;      LINE.ANG=30  
HOLE.NUM=6

5. After all parameter setting, the message window will display "HOLE 1". Move the machine table until "0.000" displays in X, Y window; it is the position of centre of the first hole. And then press  to enter EDM function to process hole 1. After hole 1 is machined, DRO returns BHC.

6. Process hole 2;

Press  and the message window will display "HOLE 2". Move the machine table until "0.000" displays in X, Y window; it is the position of centre of the second hole. And then press to  enter EDM function to process hole 2. After hole 2 is machined, DRO returns BHL.

7. Process other holes in the same way.

Press  to return normal display state when all holes are machined.

## Chapter 6 CALCULATOR FUNCTION

XH provides arithmetic operation such as plus, minus, multiply and divide, which convenient for operator to processing work piece according to the drawing.

### 6.1 Enter and exit Calculator Function

In normal display state: press  to enter calculator function

In calculator state: press  to exit calculator function

### 6.2 Calculating Example



Example 1:  $123 + 76 \times 58 - 892 / 63$



Example 2:  $358 + 456 \times \sin^{-1}(-0.5)$



Note:

1. If incorrect data is inputted, press  to cancel and input again.
2. Error would occur when calculating incorrectly, such as "0" is used as divisor or proceeding arcsine when absolute value is more than 1. In this case, the message window will display "ERR..." You can cancel this error message by pressing  and input data again.
3. The absolute value of inputted data and calculated result should be in the range of 0.000001 to 9999999, otherwise it can't be displayed.

### 6.3 Transferring the Calculated Results to Selected Axis

After calculating is finished, user can

After calculating is finished, user can

press  to transfer the calculated result to X axis, then the X window will display this value;

press  to transfer the calculated result to Y axis, then the Y window will display this value;

press  to transfer the calculated result to Z axis, then the Z window will display this value;

### 6.4 Transferring the Current Display Value in Window to Calculator

In calculator state:

Press  to transfer the display value in X window to calculator.

Press  to transfer the display value in Y window to calculator.

Press  to transfer the display value in Z window to calculator.



# Chapter 7 INITIAL SYSTEM SETTINGS

Function:

Set various parameters according to actual operation.

Parameter Items:

|            |   |
|------------|---|
| SEL SYS    | Setting the number of linear scale        |
| DIRECT     | Setting positive direction for counter    |
| LIN COMP   | Setting linear compensation               |
| R OR D     | Radius/Diameter Mode                      |
| Z DIAL     | Setting Z axis Dial                       |
| RESOLUTE   | Setting the resolution of scale           |
| RELAY.MOD  | Setting relay mode                        |
| EDM MODE   | Setting EDM mode                          |
| SDM DIR    | Setting the input mode of SDM             |
| ERROR      | Enable / Disable error message display    |
| SHRINK     | Setting shrinkage ratio                   |
| DEEP.COMP  | Enable/Disable the electrode compensation |
| SLOP.MODE  | Setting the slope machining mode          |
| LATH.MODE  | Setting the lathe mode                    |
| RI MODE    | Setting RI mode                           |
| AUTO. SCH  | Detecting the edge automatically or not   |
| AXIS.TYPE  | Setting the type of axis                  |
| STEP.MODE  | Select the step mode in ARC processing    |
| ANGLE.MODE | Select the angle display mode             |
| ANGLE.TYPE | Select the angle display type             |
| ALL CLS    | Clearing all customer settings            |

**NOTE: what you have changed (except "ALL.CLS") would not be saved if you quit "SETUP" (initial system settings) without selecting "EXIT" item.**

## 7.1 Enter/Exit Initial System Settings

Press **ENTER** to enter initial system setting after DRO powers on in 1 second; then "SETUP" displays in message window.  
Press **↑** or **↓** to select the item you want to change.

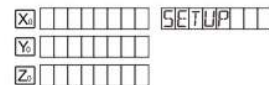

If you want to quit initial settings: press **↑** or **↓** until "EXIT" appears in message window and press **ENTER**.

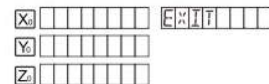

## 7.2 Setting the type of DRO

Because XH series DROs (two axes or three axes DRO) share the same software and their functions have some differences, DRO type must be set before use. ALL CLS has no effect on type of DRO.

1. Enter "SETUP" and press **↑** or **↓** until "SEL SYS" appears in message window;
2. Press **ENTER**, then Y window displays "2" or "3".  
"2" means the DRO type is XH-2;  
"3" means the DRO type is XH-3.
3. If press **2**, Y window displays "2";  
If press **3**, Y window displays "3";
4. Press **ENTER** to save your selection and exit this item;  
Press **AC** to cancel your operation and exit this item;

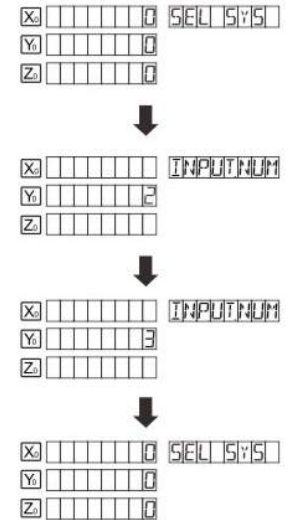

## 7.3 Setting Positive Direction for Counter

If the linear scale is installed as the figure (facing operators):  
Direction "0" means the display value will increase when scale moves from right to left and decrease when scale moves from left to right.

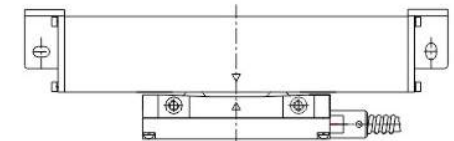

Direction "1" means the display value will increase when scale moves from left to right and decrease when scale moves from right to left.  
The counting direction of the scale is set by the erector, and the operator had better not change it.  
Default: 0

STEPS:

1. Enter "SETUP" and then press **↑** or **↓** until "DIRECT" appears in message window.
2. Press **ENTER** to enter direction setup;  
X window, Y window and Z window display "0" or

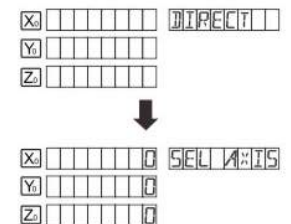

"1" separately. "0" means the opposite counter direction for "1", in other words, "0" means A signal exceed B signal and the counts increase during counting. Vice bversa. Message window displays "SEL AXIS", which means the next step is to select axis.

3. Select axis

- Press **X** to change X axis counting direction;
- Press **Y** to change Y axis counting direction;
- Press **Z** to change Z axis counting direction;

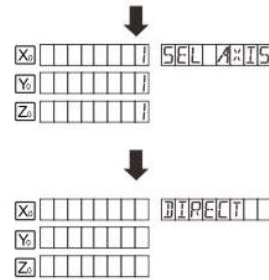

- 4. Press **ENTER** to confirm your selection and exit.
- Press **AC** to cancel your change and exit.

### 7.4 Setting Linear Compensation

#### Definition

Linear error: There is always an error between actual measure value and standard value. If it is distributed around the scale travel linearly, the error is defined as linear error. For example, the scale valid length is 400mm. if the measure value is 400mm and the standard value is 400.040mm: There is a  $\Delta L$  of 40 $\mu$ m. If 40 $\mu$ m is distributed around the scale linearly, there is a  $\Delta L$  of 10 $\mu$ m when the scale travels 100mm; a  $\Delta L$  of 20 $\mu$ m when the scale travels 200mm; a  $\Delta L$  of 30 $\mu$ m when the scale travels 300mm.

Linear compensation: Compensate the linear error to make display value equals to standard value.

**NOTES: The linear compensation is set by erector. Operator had better not change it, or the accuracy of linear scale will be worse.**

Default coefficient: 0

The calculation of compensation coefficient:

$$\text{coefficient} = \frac{(\text{measurement} - \text{standard value}) \times 1000,000}{\text{standard value}}$$

Example:

|                    |  |
|--------------------|--|
| Measurement        | 400.000mm  |
| Standard value     | 400.040mm  |
| Compensation value | $(400.000 - 400.040) \times 1000,000 / 400 = -100$ |
| Unit:              | $\mu$ m/m;   |

Set linear error compensation: X axis is 100; Y axis is 50; Z axis is -100.

STEPS:

- 1. Enter "SETUP", then press **↑** or **↓** until message window displays "LIN COMP".

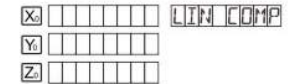

- 2. Press **ENTER**

X window, Y window, Z window displays the former linear error compensation coefficient separately. Message window displays "SEL AXIS" which indicates that the next step is to select axis.

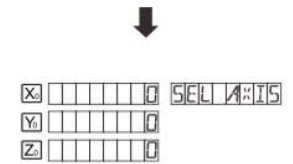

- 3. Select axis

Press **X** to select X axis.

- Note: Press **X** to select X axis. Data in X window flashes which indicating that you can input the linear error compensation for X axis;**

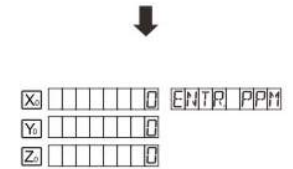

Press **Y** to select Y axis. Data in Y window flashes which indicating that you can input the linear error compensation for Y axis;

Press **Z** to select Z axis. Data in Z window flashes which indicating that you can input the linear error compensation for Z axis;

Message window displays "ENTR.PPM", indicating it is waiting for a data to be inputted.

- 4. Press **1 0 0 ENTER** in turn;

If incorrect number is input, press **AC** to cancel and input again.

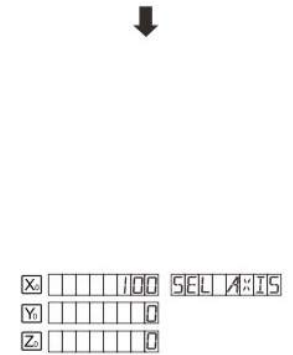

- 5. Input the error compensation coefficient for Y axis;

Press **Y 5 0 ENTER** in turn;

Input the error compensation coefficient for Z axis;

Press **Z 1 0 0 ± ENTER** in turn.



- 6. Press **ENTER** to confirm your setting and exit linear error compensation setup.

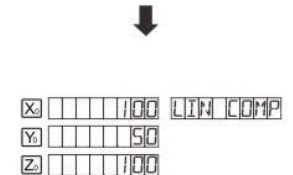

### 7.5 Toggle Between R/D Display Mode

Center Lathe

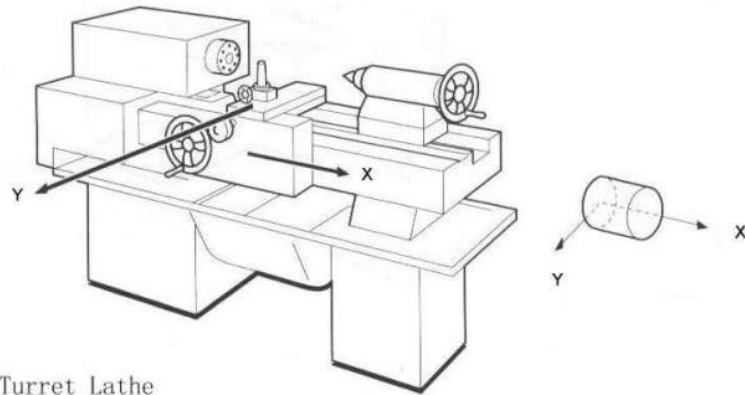

Turret Lathe

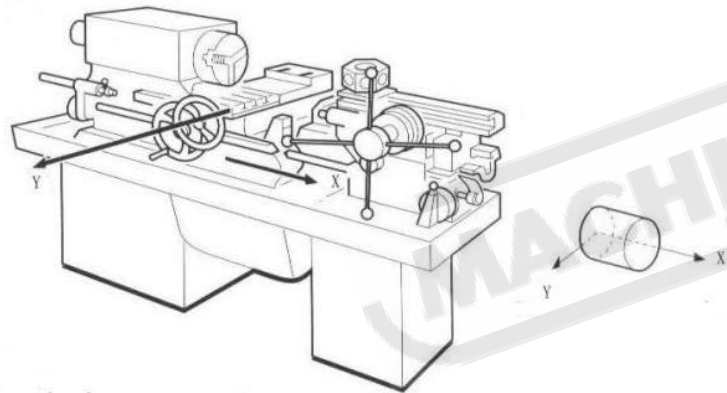

Face Lathe

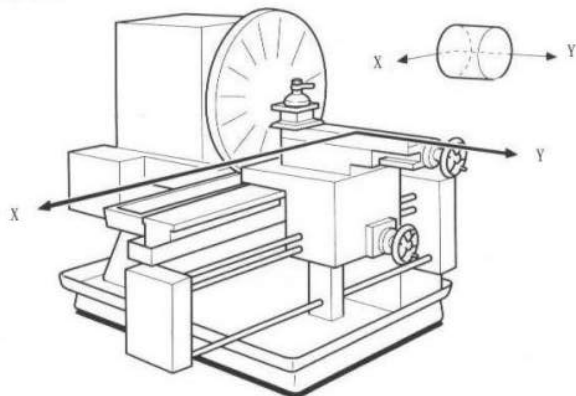

In common case, the display value is the distance between lathe tools and the coordinate origin. This display mode is called MODE R. When process cylinder given diameter measurement, diameter is the double distance between lathe tool and coordinate datum. The DRO will display the diameter in MODE D

Default mode: mode R.

STEPS:

1. Enter "SETUP" and press or until the message window displays "R OR D";
2. Press X window, Y window and Z window displays "0" or "1" separately. "0" is mode R, which means the display value equals the actual measurement. "1" is mode D where the display value equals the double actual measurement. Message window displays "SEL AXIS", which indicates the next step is to select axis;
3. Select axis  
Press to change the R/D mode of X axis;  
Press to change the R/D mode of Y axis;  
Press to change the R/D mode of Z axis;
4. Press to save your change and exit;  
Press to save your change and exit;

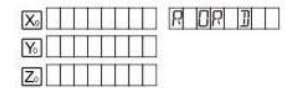
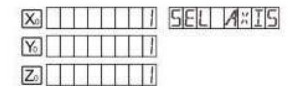
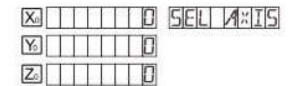
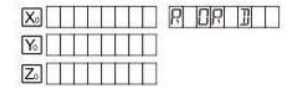

### 7.6 Setting Z axis Dial

Z axis Dial should be set if Z axis is emulated for WE6800-2 and only install linear scale for X, Y axis. Z axis Dial means the distance the Z axis travels when screw runs a revolution.

Default value: 2.5mm

Set Z axis Dial 2.4 mm:

1. Enter "SETUP" ,then press or until message window displays "Z DIAL";
2. Press Y window displays the former Z axis Dial; Message window displays "Z DIAL";

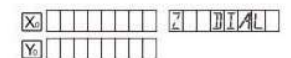



3. Input the Z axis Dial;

Press **[2]** **[.]** **[4]** in turn to input Z axis Dial;

If incorrect data has been inputted, press **[AC]** to cancel and input again;

If a minus has been inputted, the DRO will accept its absolute value instead.

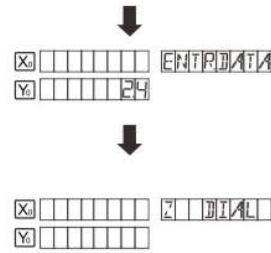

4. Press **[ENTER]** to confirm your setting and exit Z DIAL setup.

### 7.7 Setting the Resolution of Scale

Different scale has different resolution. WE6800 DRO can connect with 10 kinds of scale, and these resolutions are 0.05μm, 0.1μm, 0.2μm, 0.5μm, 1μm, 2μm, 5μm, 10μm, 20μm, 50μm. The resolution must be set to match the linear scale. This parameter is set by erector, operator had better not change it.

Default resolution: 5μm

Set the resolution of X axis, Y axis, Z axis as 1μm.

STEPS:

1. Enter "SETUP" and press **[↑]** or **[↓]** until "RESOLUTE" appears in message window;



2. Press **[ENTER]**,

X window, Y window and Z window displays the former resolution of each axis separately. Message window displays "SEL AXIS", which indicates the next step is to select axis.



3. Select axis.

Press **[X]** to change the resolution of X axis, then data in X windows flashes.

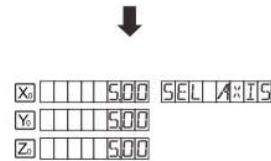

Press **[Y]** to change the resolution of Y axis, then data in Y windows flashes.

Press **[Z]** to change the resolution of Z axis, then data in Z windows flashes.

4. Press **[↑]** or **[↓]** to scroll through 0.05, 0.10, 0.20, 0.50, 1.00, 2.00, 5.00, 10.00, 20.00, 50.00. Press **[ENTER]** to select "1.00" when it appears and return "SEL.RXIS" state. Press **[AC]** to cancel your selection.

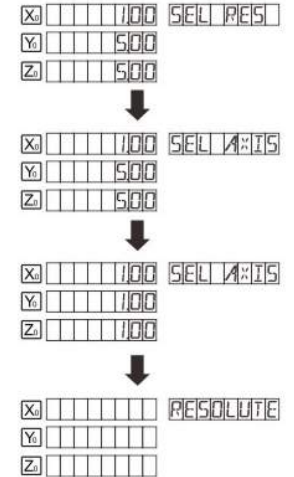

5. Set the resolution of Y axis: Z axis by repeating step 3-4.

6. Press **[ENTER]** to exit "RESOLUTE" setup.

### 7.8 Setting Relay Mode

The relay will send out an ON/OFF signal when process to target position. EDM.Relay interface has three pins: common, normal close and normal open. XH series provides four Relay modes. Operator can set it according to your circuit.

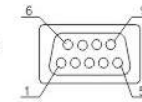

| PIN | NAME         | COLOR |
|-----|--------------|-------|
| 1   | NC           |       |
| 2   | COMMON       | ORG   |
| 3   | NORMAL CLOSE | BRW   |
| 4   | NC           |       |
| 5   | IN+          | RED   |
| 6   | NORMAL OPEN  | YEL   |
| 9   | IN-          | BLK   |

Normal close and common pin:

| MODE | Power ON | ENTER EDM | PROCESS TO TARGET POSITION | EXIT EDM | Power off |
|------|----------|-----------|----------------------------|----------|-----------|
| 1    | close    | close     | open                       | close    | open      |
| 2    | open     | open      | close                      | open     | open      |
| 3    | close    | open      | close                      | close    | open      |
| 4    | open     | close     | open                       | open     | open      |

Default value: MODE 2.

STEPS:

1. Enter "SETUP", then press **[↑]** or **[↓]** until the message window displays "RELAY.MOD";

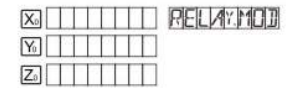

2. Press **[ENTER]**, then the Y window displays "0" or "1";

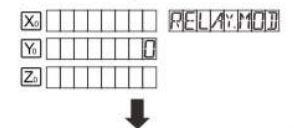

3. Press **0** or **1** to set the RELAY MODE.

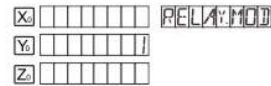

4. Press **ENTER** to confirm your setting and exit

"RELAY.MODE";

Press **AC** to cancel your change and exit "RELAY.MODE".

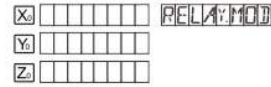

### 7.9 Setting the EDM Mode

XH series provides 7 EDM modes. For detail information, please refer to chapter five. EDM mode must be set before EDM machining.

Default mode: MODE 1.

Set the EDM mode to mode 3.

STEPS:

1. Enter "SETUP" then press **↑** or **↓** until message window displays "EDM MODE";

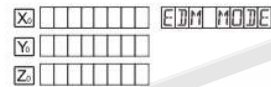

2. Press **ENTER**, then Y window displays the former EDM mode;



3. Press **3** to change the mode;  
Press the number key which you want to set the mode.

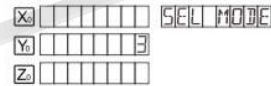

4. Press **ENTER** to confirm your setting and exit "EDM.MODE" setup.

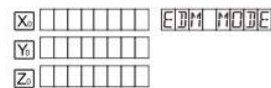

Press **AC** to cancel your change and exit "EDM.MODE" setup;

### 7.10 Setting the Input Mode in SDM Coordinate

XH series DRO provides two inputting data mode in SDM coordinate:

MODE 0 (Normal inputting mode): the data the DRO accept equals the inputted data;

MODE 1 (Special inputting mode): the data the DRO accept equals the negative of the inputted number.

Example: Set SDM mode 1.

1. Enter "SETUP" then press **↑** or **↓** until the message window displays "SDM DIR";

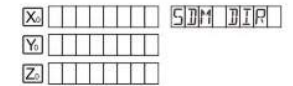

2. Press **ENTER**, Y window displays the former SDM mode;

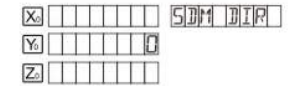

3. Press **1** to set the SDM mode 1;

**NOTE: press 0 to set the SDM mode 0.**



4. Press **ENTER** to confirm your setting and exit "SDM.MODE".

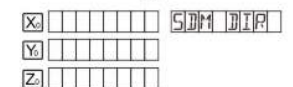

Press **AC** to cancel your change and exit "SDM.MODE".

### 7.11 Enable / Disable ERROR Signal

XH serial DRO provides the function of checking whether the counting signal is normal or not. It can display the ERROR information if some error occurs in counting signal. User can enable or disable this function.

"0" means no error information will be displayed and the DRO continue to work when there is some wrong with linear scale or encoder.

"1" means error information will be displayed when error occurs.

Default setting: 0 (disable display error message).

Example: Enable display ERROR message.

STEPS:

1. Enter "SETUP" then press **↑** or **↓** until "ERROR" message window displays "SDM DIR";

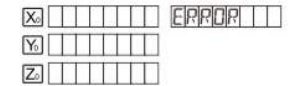

2. Press **ENTER**, Y window displays the former "0";



3. Press **1** to change it to enable error message;



**Note: press 0 to change to disable error message.**

- Press **ENTER** to confirm your change and exit "ERROR" setup.  
Press **AC** to cancel your change and exit "ERROR" setup.

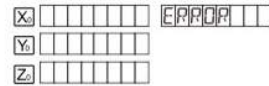

### 7.12 Setting Shrinkage Ratio

Shrinkage ratio must be set before using shrinkage function. Shrinkage ratio must be the range of 0.1 to 10. Default ratio: 1.000

Set the shrinkage ratio 0.975.  
STEPS:

- Enter "SETUP" and press **↑** or **↓** until "SHRINK" appears in message window;
- Press **ENTER**, then Y window displays the former shrinkage ratio and message window displays "SHRINK";
- Input shrinkage ratio;  
Press **0** **9** **7** **5** in turn;  
If incorrect data has been input, press **AC** to cancel and input again.
- Press **ENTER** to confirm your input and exit "ERROR".

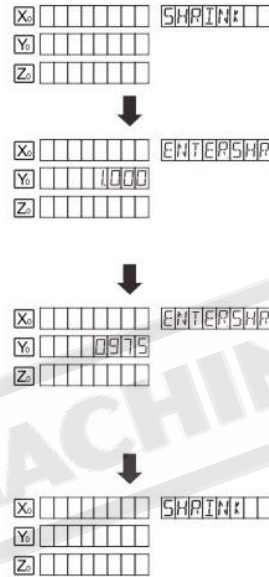

**Note:** shrinkage ratio =  $\frac{\text{Dimensions of the finished product}}{\text{Dimensions of the working piece}}$

### 7.13 Enable/Disable EDM Depth Compensation

In EDM machine, deep compensation is not necessary and this function is disabled normally. It must be enabled before using it. Default setting: disable depth compensation.

STEPS:

- Enter "SETUP" and press **↑** or **↓** until the message window displays "DEEP.COMP";

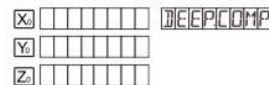

- Press **ENTER**.  
Y window displays the former setting.  
"0" means deep compensation is disabled;  
"1" means deep compensation is enabled;
- Press **0** or **1** to change mode of depth compensation;
- Press **ENTER** to confirm your change and exit.

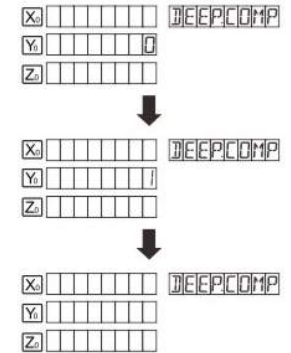

### 7.14 Setting the Slope Machining Parameter

Parameter can be set in two ways in slope machining :

- Set the step of second axis (Z STEP) in one plane: for XY plane, set the step of Y axis; for YZ plane and XZ plane set the step of Z axis.
- Set MAX CUT.

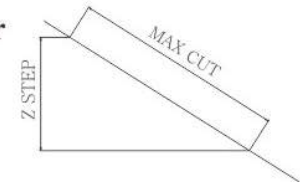

Default setting: the step of the second axis (Z STEP).

Set the slope machining parameter MAX CUT.

STEPS:

- Enter "SETUP" and press **↑** or **↓** until message window displays "SLOP.MODE";
- Press **ENTER**,  
Y window displays the former parameter mode;  
Press **1** to select MAX CUT parameter mode;  
**Note:** Press **0** to select Z STEP parameter mode.
- Press **ENTER** to save the change and exit this item.  
Press **AC** to cancel your change and exit this item.

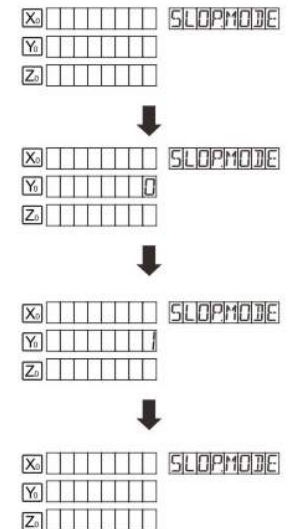



### 7.15 Setting Lathe Mode

Lathe mode 0: Disable lathe function;  
 Lathe mode 1: X window display value = the position of X axis + the position of Y axis;  
 Lathe mode 2: X window display value = the position of X axis + the position of Z axis;  
 Default mode: disable lathe mode.

Set the lathe as mode 1.

STEPS:

1. Enter "SETUP" and press or until the message window displays "LATH.MODE";

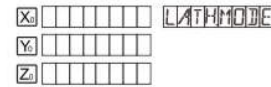

2. Press , then the Y window displays the former lathe mode;

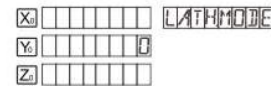

3. Set the new lathe mode; Press

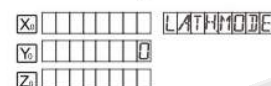

**Note: press or or to change the lathe mode.**

4. Press to confirm your change and exit "LATH.MODE".



### 7.16 Setting RI MODE

XH series provides 8 RI modes: mode 1 to mode 8, every mode has its corresponding wave of A, B and RI.  
 Default mode: MODE 1

Set RI MODE 5 for X axis .

STEPS:

1. Enter "SETUP", then press or until the message window displays "RI MODE";

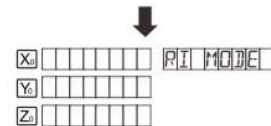

2. Press X window, Y window and Z window displays the former RI mode respectively, message window displays "SEL.AXIS" which indicating the next step is to select axis;

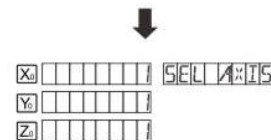

3. Select axis;

Press to change RI mode of X axis. The number in X window flashes;

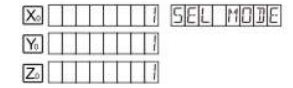

Press to change RI mode of Y axis, and the data in Y window flashes;

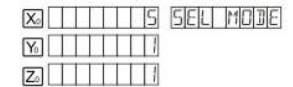

Press to change RI mode of Z axis, and the data in Z window flashes;



4. Press or then "1", "2", "3", "4", "5", "6", "7", "8" will be displayed in turn;

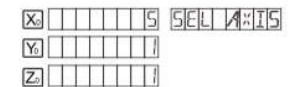

When "5" is displayed in message window, press to change RI mode and return "SEL.AXIS" state.

Press to cancel your selection and return "SEL.AXIS" state.



5. Press , to exit "RI.MODE" setup.

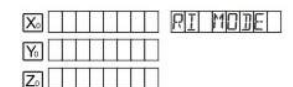

### 7.17 Enable/Disable Edge Detection

Function: XH series DRO can zero Z axis display value in normal display state when an external signal is detected if edge detection is enabled  
 0: Edge detection is disabled, The DRO doesn't zero Z axis display value in normal display state when external signal detected.  
 1: Edge detect is enable. The DRO zeroes Z axis display value in normal display state when an external signal is detected.  
 Default value: 0 (edge detection is disable)

Example: Enable edge detection

STEPS:

1. Enter "SETUP", then press or until message window displays "AUTO.SCH";



2. Press , then Y window will display the former setting;

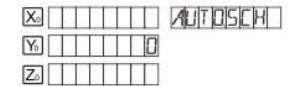

3. Press , to enable edge detects;



Note: press **0** to disable edge detects

X: [ ] [ ] [ ] [ ] [ ] [ ] [ ] [ ] [ ] [ ] [ ] [ ] [ ] [ ] [ ] AUTOSCH  
Y: [ ] [ ] [ ] [ ] [ ] [ ] [ ] [ ] [ ] [ ] [ ] [ ] [ ] [ ] [ ]  
Z: [ ] [ ] [ ] [ ] [ ] [ ] [ ] [ ] [ ] [ ] [ ] [ ] [ ] [ ] [ ]



4: Press **ENTER** to confirm your selection and exit.

X: [ ] [ ] [ ] [ ] [ ] [ ] [ ] [ ] [ ] [ ] [ ] [ ] [ ] [ ] [ ] AUTOSCH  
Y: [ ] [ ] [ ] [ ] [ ] [ ] [ ] [ ] [ ] [ ] [ ] [ ] [ ] [ ] [ ]  
Z: [ ] [ ] [ ] [ ] [ ] [ ] [ ] [ ] [ ] [ ] [ ] [ ] [ ] [ ] [ ]

## 7.18 Toggle between Linear Scale and Rotary Encoder

Both linear scale and rotary encoder can be installed in any axis. The linear scale is used to measure distance; the rotary encoder is used to measure angle.

Default: linear scale.

Set rotary encoder in Z axis.

STEPS:

1. Enter "SETUP" and press **↑** or **↓** until the message window displays "AXIS.TYPE";

X: [ ] [ ] [ ] [ ] [ ] [ ] [ ] [ ] [ ] [ ] [ ] [ ] [ ] [ ] [ ] AXISTYPE  
Y: [ ] [ ] [ ] [ ] [ ] [ ] [ ] [ ] [ ] [ ] [ ] [ ] [ ] [ ] [ ]  
Z: [ ] [ ] [ ] [ ] [ ] [ ] [ ] [ ] [ ] [ ] [ ] [ ] [ ] [ ] [ ]



2. Press **ENTER**:

X, Y, Z window displays the former type.  
"LINEA" means linear scale.  
"ENCODE" means rotary encoder.  
Message window displays "SEL AXIS", which means the next step is to select axis.

X: [ ] [ ] [ ] [ ] [ ] [ ] [ ] [ ] [ ] [ ] [ ] [ ] [ ] [ ] [ ] SEL AXIS  
Y: [ ] [ ] [ ] [ ] [ ] [ ] [ ] [ ] [ ] [ ] [ ] [ ] [ ] [ ] [ ]  
Z: [ ] [ ] [ ] [ ] [ ] [ ] [ ] [ ] [ ] [ ] [ ] [ ] [ ] [ ] [ ]



3. Set Z axis are installed with rotary

Press **Z** until display in Z window is "ENCODE";

Note: Press **X** to change X axis;

Press **Y** to change Y axis;

Press **Z** to change in Z axis;

X: [ ] [ ] [ ] [ ] [ ] [ ] [ ] [ ] [ ] [ ] [ ] [ ] [ ] [ ] [ ] SEL AXIS  
Y: [ ] [ ] [ ] [ ] [ ] [ ] [ ] [ ] [ ] [ ] [ ] [ ] [ ] [ ] [ ]  
Z: [ ] [ ] [ ] [ ] [ ] [ ] [ ] [ ] [ ] [ ] [ ] [ ] [ ] [ ] [ ]



4. Press **ENTER** to confirm your new set and exit.

Press **AC** to cancel your new set and exit.

X: [ ] [ ] [ ] [ ] [ ] [ ] [ ] [ ] [ ] [ ] [ ] [ ] [ ] [ ] [ ] AXISTYPE  
Y: [ ] [ ] [ ] [ ] [ ] [ ] [ ] [ ] [ ] [ ] [ ] [ ] [ ] [ ] [ ]  
Z: [ ] [ ] [ ] [ ] [ ] [ ] [ ] [ ] [ ] [ ] [ ] [ ] [ ] [ ] [ ]

## 7.19 Step Mode of ARC

In ARC function, if the plane is not XY, you can setup the step mode. There are two modes. Mode 0 is Z STEP mode and Mode 1 is MAX CUT mode.

Default setting: Z STEP.

For example, set the mode as STEP mode.

STEPS:

1. Enter "SETUP" and press **↑** or **↓** until the message window displays "STEP. MODE";

X: [ ] [ ] [ ] [ ] [ ] [ ] [ ] [ ] [ ] [ ] [ ] [ ] [ ] [ ] [ ] STEPMODE  
Y: [ ] [ ] [ ] [ ] [ ] [ ] [ ] [ ] [ ] [ ] [ ] [ ] [ ] [ ] [ ]  
Z: [ ] [ ] [ ] [ ] [ ] [ ] [ ] [ ] [ ] [ ] [ ] [ ] [ ] [ ] [ ]



2. Press **ENTER**

Y window displays the former setting.

"0" means Z STEP;

"1" means MAX CUT;

The message window displays "SEL MODE", which means selecting step mode of ARC next step.

X: [ ] [ ] [ ] [ ] [ ] [ ] [ ] [ ] [ ] [ ] [ ] [ ] [ ] [ ] [ ] SEL MODE  
Y: [ ] [ ] [ ] [ ] [ ] [ ] [ ] [ ] [ ] [ ] [ ] [ ] [ ] [ ] [ ]  
Z: [ ] [ ] [ ] [ ] [ ] [ ] [ ] [ ] [ ] [ ] [ ] [ ] [ ] [ ] [ ]



X: [ ] [ ] [ ] [ ] [ ] [ ] [ ] [ ] [ ] [ ] [ ] [ ] [ ] [ ] [ ] SEL MODE  
Y: [ ] [ ] [ ] [ ] [ ] [ ] [ ] [ ] [ ] [ ] [ ] [ ] [ ] [ ] [ ]  
Z: [ ] [ ] [ ] [ ] [ ] [ ] [ ] [ ] [ ] [ ] [ ] [ ] [ ] [ ] [ ]



3. Set mode as STEP mode.

Press **1**, then Y window displays the changed mode.

X: [ ] [ ] [ ] [ ] [ ] [ ] [ ] [ ] [ ] [ ] [ ] [ ] [ ] [ ] [ ] STEPMODE  
Y: [ ] [ ] [ ] [ ] [ ] [ ] [ ] [ ] [ ] [ ] [ ] [ ] [ ] [ ] [ ]  
Z: [ ] [ ] [ ] [ ] [ ] [ ] [ ] [ ] [ ] [ ] [ ] [ ] [ ] [ ] [ ]

4. Press **ENTER** to confirm your change and exit "STEP.MODE".

Press **AC** to cancel your new set and exit.

## 7.20 Angle Display Mode

XH series provides 3 angle display modes. In Mode 1, the angle is in the range of  $0^{\circ}$  to  $360^{\circ}$ ; in mode 2, the angle is in the range of  $-360^{\circ}$  to  $360^{\circ}$ ; and in mode 3, the angle is in the range of  $-180^{\circ}$  to  $180^{\circ}$ .  
Default mode: MODE 1.

Set the EDM mode as mode 2.

STEPS:

1. Enter "SETUP", then press **↑** or **↓** until message window displays "ANGL. MODE";

X: [ ] [ ] [ ] [ ] [ ] [ ] [ ] [ ] [ ] [ ] [ ] [ ] [ ] [ ] [ ] ANGLMODE  
Y: [ ] [ ] [ ] [ ] [ ] [ ] [ ] [ ] [ ] [ ] [ ] [ ] [ ] [ ] [ ]  
Z: [ ] [ ] [ ] [ ] [ ] [ ] [ ] [ ] [ ] [ ] [ ] [ ] [ ] [ ] [ ]



2. Press **ENTER**, then Y window displays the former angle mode;

The message window displays "SEL MODE", which means to select angle display mode next step.

X: [ ] [ ] [ ] [ ] [ ] [ ] [ ] [ ] [ ] [ ] [ ] [ ] [ ] [ ] [ ] SEL MODE  
Y: [ ] [ ] [ ] [ ] [ ] [ ] [ ] [ ] [ ] [ ] [ ] [ ] [ ] [ ] [ ]  
Z: [ ] [ ] [ ] [ ] [ ] [ ] [ ] [ ] [ ] [ ] [ ] [ ] [ ] [ ] [ ]



3. Set the angle display mode as mode 2.

Press **2** then the Y window displays the changed mode;

X: [ ] [ ] [ ] [ ] [ ] [ ] [ ] [ ] [ ] [ ] [ ] [ ] [ ] [ ] [ ] SEL MODE  
Y: [ ] [ ] [ ] [ ] [ ] [ ] [ ] [ ] [ ] [ ] [ ] [ ] [ ] [ ] [ ]  
Z: [ ] [ ] [ ] [ ] [ ] [ ] [ ] [ ] [ ] [ ] [ ] [ ] [ ] [ ] [ ]



4. Press **ENTER** to confirm your setup and exit "ANGLE.MODE" setup.

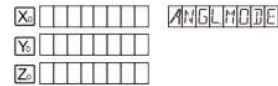

Press **AC** to cancel your change and exit "ANGL.MODE" setup;

### 7.21 Angle display type

There are two angle display types for XH series.  
 TYPE 0: indicate angle display is DD.  
 TYPE 1: indicate angle display is DMS.  
 Default value: TYPE 0.

Set the angle display type as DMS.

Steps:

1: First enter "SETUP", press **↑** or **↓** until the message window display "ANGE.TYPE".

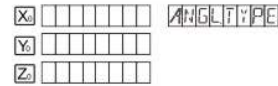

2: Press **ENTER**  
 Y window display the former setup.  
 Z window display the former angle mode is DD.



3: Set the angle display mode as MODE1.  
 Press **1**, Y window display the changed mode,  
 Z window display current mode is DMS

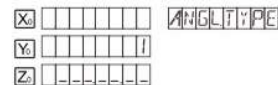

4: Press **ENTER**, the new setup has been saved and exit this setup.  
 Press **AC**, exit this setup and the setup unsaved.

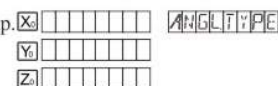

### 7.22 Load default setup

Function: Clear all data except the linear compensation and DRO type. DRO will load default setup for all parameters. After loading default setup, user must search RI once to enable resuming ALE datum function; otherwise to resume the datum by RI is unable.

STEPS:

1. Enter "SETUP", then press **↑** or **↓** until the message window displays :ALL CLS";

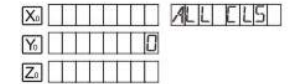

2. Press **ENTER** and message windows display "PASSWORD" indicating the operator to input password. At this moment, there are two selections:

- A Press **AC** to quit "ALL.CLS";
- B Enter the correct password to clear all parameters and load default setup;



3. Input the password;

Press **1 9 9 9 ENTER** in turn to load default value.

The message window displays "WAITING", which means the clearing is going on.



4. Return normal display state after loading default setup is finished.





The default setup for all parameters is as following:

- Counting direction is mode 0;
- The R/D is mode R ;
- Z DIAL = 2.5mm;
- Resolution = 5 $\mu$ m;
- EDM mode is MODE 1;
- Relay mode is mode 0;
- Shrinkage ration 1.000;
- Input mode in SDM as 0, display value = input value;
- Deep compensation is disabled;
- Lathe function is disabled;
- Slope machining parameter is Z step;
- RI MODE is mode 8;
- Disable the edge detection;
- Linear scale is installed for any axis;
- Angle display mode is mode 1: 0~360;
- Angle display type is 0: DD;
- ARC machining parameter is Z step.

## Chapter 8 TROUBLE SHOOTING

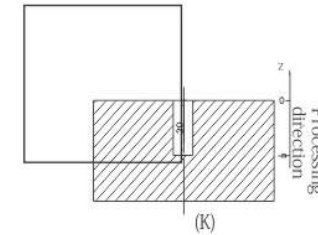

The following are the easy solvent for troubleshooting. If they can not work: please contact with distributor for more service.

| Trouble                      | Possible Reason  | Solvent   |
|------------------------------|--|---|
| No display                   | A The DRO isn't powered.<br>B AC power voltage is not in the range of 100V to 240V.  | A Check the fuse is OK or not.<br>B Check the socket is loose.<br>C Check the input power voltage is in the range of 100V to 240V.  |
| Cover is charged             | A Poor grounding is float<br>B Leakage of electricity  | Check the lathe and DRO are well grounded.  |
| Display value is doubled     | A Improper resolution<br>B Display mode D  | A Set proper resolution.<br>B Set display mode R.   |
| No counting                  | A Poor contact of scale<br>B No scale signal output<br>C Useless of counting function  | Exchange scale and check again.   |
| Display value is in disorder | Memory is disorder   | A Clear system.<br>B Check compensation is proper.  |
| Erroneous counting           | A Poor precision of lathe<br>B Too fast run speed of the lathe<br>C Proper scale precision<br>D Improper resolution is set<br>E Improper linear error compensation<br>F Useless of scale | A Repair lathe.<br>B Reduce the move speed of scale.<br>C Reinstall scale.<br>D Set proper resolution.<br>E Set proper linear error compensation.<br>F Repair or exchange linear scale. |